

ARISE

Markerboard & Marker Wall

Claridge



The Arise Series dry erase whiteboard offers sophistication with a minimal 1/4" satin anodize face trim and an incredibly smooth LCS Porcelain surface that delivers a great writing experience. LCS Porcelain steel accepts magnets, won't ghost or stain, and is warrantied for life.

- Featuring our best in class writing surface, LCS Porcelain
- Available in both markerboard and chalkboard options
- LCS Porcelain surface is SCS Indoor Advantage certified

ARISE

Markerboard & Marker Wall



Arise Marker Wall

STANDARD MARKERBOARD SIZES (HxW)

4' x 4'	4' x 6'	4' x 8'	4' x 10'
3' x 4'			
2' x 3'			

STANDARD MARKER WALL SIZES (HxW)

8' x 4'
10' x 4'

SPECIFICATIONS

- LCS Porcelain surface
- Arise 1/4" thickness allows for thin-mount aesthetics
- Available in markerboard and marker wall sizes
- LCS Porcelain surface is SCS Indoor Advantage certified, eco-friendly, and emits no VOC's

CLARIDGE LCS PORCELAIN HIGHLIGHTS

- Premium writing surface
- Projectable surface
- Low reflectivity
- Accepts magnetic accessories
- Bacteria resistant
- Lifetime warranty

COLORS

- Markerboard colors in white, light gray, and beige
- Chalkboard colors in green, black, and gray

[View Claridge LCS Porcelain Colors HERE](#)

MARKERBOARD

MARKER WALL



800-434-4610
claridgeproducts.com



Arise Markerboard & Wall

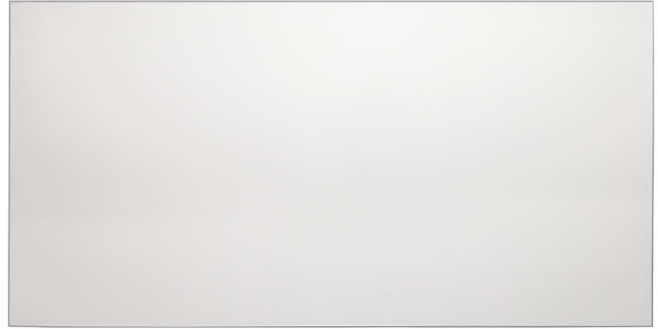

INSTALLATION INSTRUCTIONS

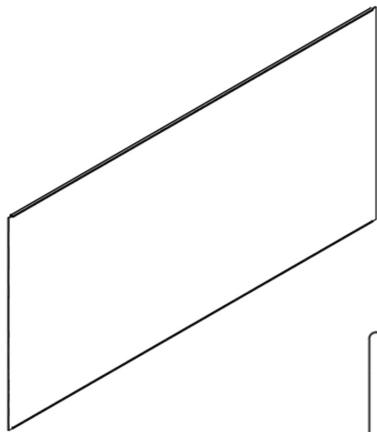

In the box:

- Arise markerboard panel
- 1191 trim (2)
- 1226 trim (2)

Not provided:

- Appropriate wall fasteners
- PL adhesive



1191



1226

WARNING

Risk of injury to installers and users

Read the entire assembly directions before beginning assembly.

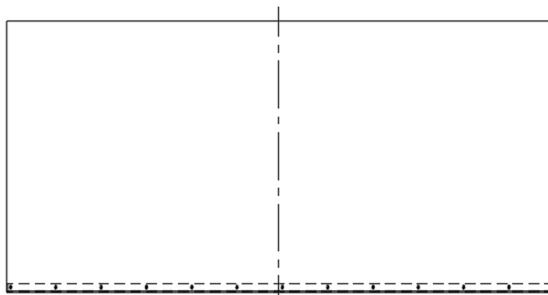

Center

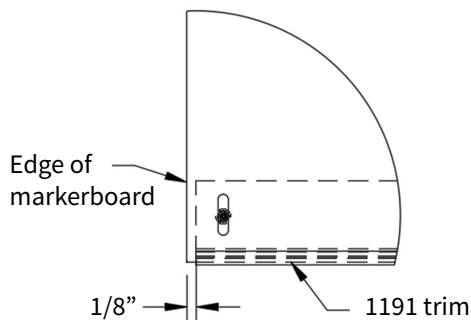

1/8"

1191 trim

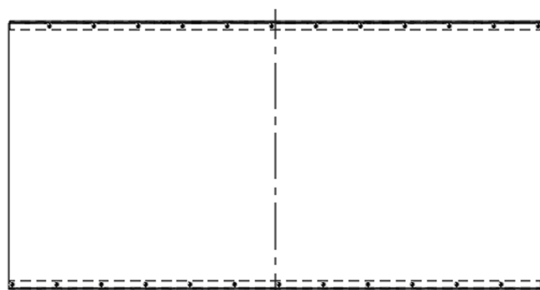

Center

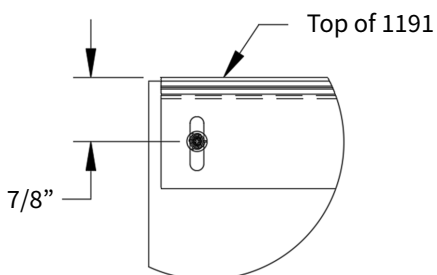

7/8"

Top of 1191

Instructions:

1. Determine the desired bottom position of the board on the wall. Mark a level line with a pencil and also mark center.
2. Place the bottom edge of the 1191 trim on the level line and centered left to right. Drill in center of every slot.
3. Using appropriate wall fasteners, attach 1191 trim to the wall. Use a straight edge, shim where necessary so that all anchor points of the hanger are in line and level.

Note If installing 1226 trim the length of the 1191 trim needs to be cut $\frac{1}{4}$ " short of overall width of the panel/panels. This will allow the boards to extend past each end of the 1191 trim $\frac{1}{8}$ ".

4. When installing the top trim. Measure up from the bottom, of the bottom trim the height of the panel plus $\frac{1}{8}$ ". Make a level line and mark center. With the top edge of the trim on the line and centered left to right. Drill in the center of each slot.
5. Using appropriate wall fasteners, attach 1191 trim to the wall. Push trim up and snug securely. Do not overtighten because trim will be tapped down to hold the panel. Use a straight edge, shim where necessary so that all anchor points of the hanger are in line and level.

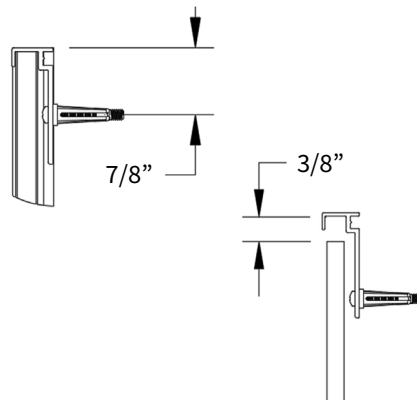

7/8"

3/8"

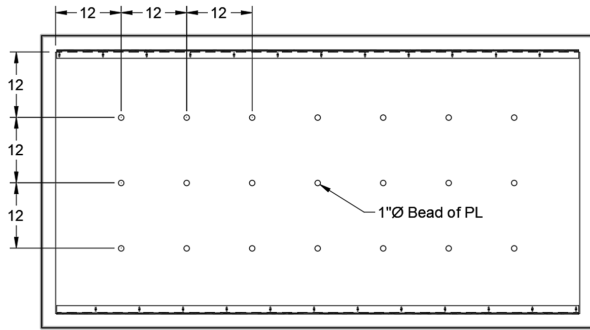

Instructions:

6. Place board face down on a clean flat surface. Apply golf ball size of PL beads in a 12" X 12" inch grid pattern as shown to the back of the panel.
7. Place panel into bottom trim press on surface to ensure back of panel glues to the wall. Gently tap the top trimmed down to secure panel. Make sure the edge of the panel overhangs trim 1/8".

Note: If installing multiple panels make sure the top trim isn't so low it prevents the next panel from sliding into place. Cut joint connector to fit between top and bottom trim. Insert the joint connector and repeat 6 & 7

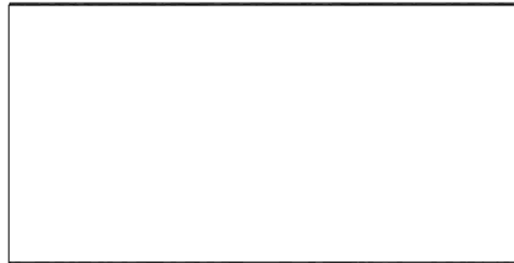
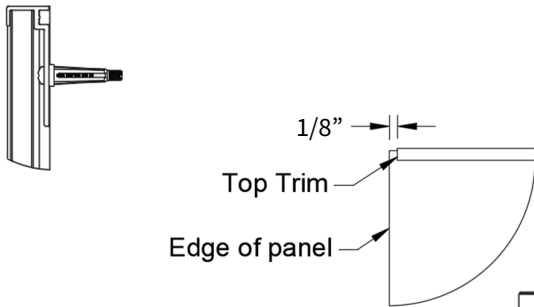

8. After panel/panels are installed and trim tapped down. Measure the overall height and cut the 1226 trim to size.
9. Apply a small bead of PL adhesive to the inside of the trim. Press the trim onto the edge of the board. Secure trim in place with painters tape until adhesive has dried.

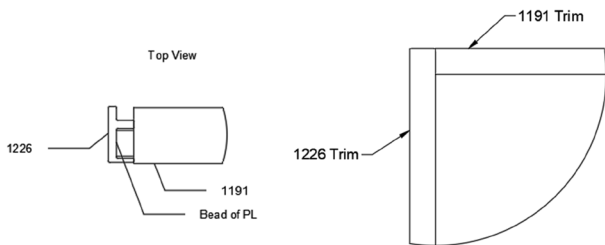

Standard Color Selections

Select from the 3 standard porcelain or 3 chalkboard colors

LCS Porcelain Colors - use with markers



No. 100 White

No. 101 Light Gray

No. 102 Beige

Chalkboard Colors - use with chalk



No. 500 Green

No. 501 Black

No. 502 Gray

Claridge LCS Porcelain enamel steel markerboard and chalkboard writing surfaces offer unsurpassed durability and performance – a lifetime of performance.

An environmentally friendly process that offers a wide range of decorative and functional colors for use on porcelain markerboards and walls.

- Smooth writing and clean erasing
- Unmatched scratch and stain resistance
- 100% non-combustible surface
- Magnetic surface
- Projection-friendly low gloss LCS surface
- Life of the Building Guarantee
- LCS Porcelain surface is SCS Indoor Advantage Certified

*Colors are reproduced with reasonable accuracy, and are for color identification purposes only.
If color is critical, contact us at 800-434-4610 to request an actual color sample.*



LCS PORCELAIN Markerboard and Chalkboard Features

ENVIRONMENTAL FEATURES

- **SCS Indoor Advantage Certified**

SCS Indoor Advantage certifications are product certification programs for low emitting interior building materials, furnishings and finish systems. SCS Indoor Advantage certified products undergo rigorous testing and must meet stringent standards for low chemical emissions based on established health standards for use in environments such as schools and healthcare facilities.

- **Cradle-to-Cradle™ Bronze Certification**

Cradle-to-Cradle Certification focuses on the characteristics of sustainable materials, products, and systems. The process places emphasis on the human and ecological health impacts of a product's ingredients, and on the ability of that product to be recycled or composted.

Third-party environmental certification assures customers and end users that products selected support healthy indoor air quality and do not emit harmful chemicals. LCS is non-combustible, gives off no toxic gases and is 99.9% recyclable.

CLEANING INSTRUCTIONS

Claridge LCS Porcelain® enamel steel surfaces are guaranteed to withstand the rigors of everyday use. Proper use and maintenance will ensure performance and keep LCS Porcelain markerboards and chalkboards looking like new. Visit claridgeproducts.com for complete cleaning and maintenance instructions.

WRITING SURFACE WARRANTY

Claridge LCS Porcelain enamel steel markerboard and chalkboard writing surfaces offer unsurpassed durability and performance – a lifetime of performance. We are so confident in the quality and dependability of our LCS Porcelain surfaces that we Guarantee it for the Life of the Building!

SPECIFICATION

Claridge markerboard and chalkboard surfaces are manufactured in accordance with PEI-1002 Manual and Performance Specifications for LCS Porcelain Enamel Writing Surfaces. The writing surface is made from steel covered on both sides with enamel coatings. Fusion bonded to the steel, the resulting LCS Porcelain surface is smooth, durable and abrasion-resistant providing the best dry-erase surface available.



POWDER COATINGS

Color Guide



An environmentally friendly process that offers a wide range of decorative, functional colors for use on glass markerboards, walls, and metal frames.

BENEFITS OF POWDER COATING

- More durable than baked enamels
- Delivers a brighter, smoother and cleaner finish
- Environmentally friendly, produces less hazardous waste than conventional liquid coatings
- Color choices are virtually unlimited with custom color matching

*Colors are reproduced with reasonable accuracy in standard Gloss finish unless noted Matte.
If match is critical, contact us at 800-434-4610 for actual samples*



Powder Coat Colors

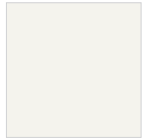

RAL9016
Traffic White

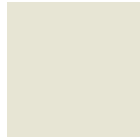

RAL9002
Grey White



RAL9018
Papyrus White



RAL7038
Agate Grey



RAL7035
Light Grey



RAL7044
Silk Grey

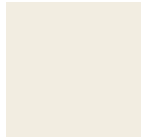

RAL9010
Pure White

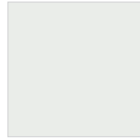

RAL9003
Signal White

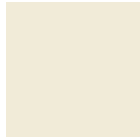

RAL9001
Cream



RAL7047
Telegrey 4



RAL7036
Platinum Grey



RAL7045
Telegrey 1



RAL7032
Pebble Grey



RAL7033
Cement Grey



RAL7042
Traffic Grey A



RAL7004
Signal Grey



RAL7046
Telegrey 2



RAL7037
Dusty Grey



RAL7030
Stone Grey



RAL7034
Yellow Grey



RAL7005
Mouse Grey



RAL7040
Window Grey



RAL7012
Basalt Grey



RAL7043
Traffic Grey B



RAL7003
Moss Grey



RAL7013
Brown Grey



RAL7039
Quartz Grey



RAL7006
Beige Grey



RAL7000
Squirrel Grey



RAL7009
Green Grey



RAL7001
Silver Grey



RAL7010
Tarpaulin Grey



RAL7023
Concrete Grey



RAL7002
Olive Grey



RAL7022
Umbra Grey



RAL7011
Iron Grey



RAL6006
Grey Olive



RAL7008
Khaki Grey



RAL7016
Anthracite Grey



RAL7026
Granite Grey



RAL7024
Graphite Grey



RAL7021
Black Grey



RAL1013
Oyster White



RAL1015
Light Ivory



RAL1014
Ivory



RAL1000
Green Beige



RAL1001
Beige



RAL1011
Brown Beige



RAL1002
Sand Yellow



RAL1019
Grey Beige



RAL1020
Olive Yellow



RAL1024
Ochre Yellow



RAL1027
Curry



RAL1032
Broom Yellow



RAL1021
Yellow



RAL1018
Zinc Yellow



RAL1033
Dahlia Yellow



RAL2009
Traffic Orange



RAL2004
Pure Orange



RAL3004
Purple Red



RAL1016
Sulfur Yellow



RAL1012
Lemon Yellow



RAL1034
Pastel Yellow



RAL2010
Signal Orange



RAL2008
Bright Red Orange



RAL3005
Wine Red



RAL1028
Melon Yellow



RAL1023
Traffic Yellow



RAL2000
Yellow Orange



RAL2011
Deep Orange



RAL3002
Carmine Red



RAL3007
Black Red



RAL1003
Signal Yellow



RAL1017
Saffron Yellow



RAL2001
Red Orange



RAL2012
Salmon Orange



RAL3003
Ruby Red



RAL3009
Oxide Red



RAL1004
Golden Yellow



RAL1006
Maize Yellow



RAL2002
Vermilion



RAL3000
Flame Red



RAL3013
Tomato Red



RAL3011
Brown Red



RAL1005
Honey Yellow



RAL1007
Daffodil Yellow



RAL2003
Pastel Orange



RAL3001
Signal Red



RAL3014
Antique Pink



RAL3012
Beige Red



RAL3015
Light Pink

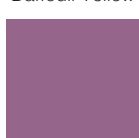

RAL4001
Red Lilac



RAL4009
Pastel Violet

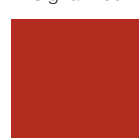

RAL3016
Coral Red



RAL4002
Red Violet



RAL4010
Telemagenta



RAL4003
Heather Violet



RAL4005
Blue Lilac

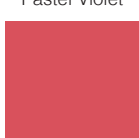

RAL3017
Rose

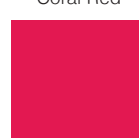

RAL3018
Strawberry Red



RAL3020
Traffic Red



RAL4004
Claret Violet

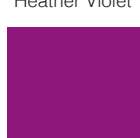

RAL4006
Traffic Purple



RAL4008
Signal Violet



RAL3022
Salmon Pink

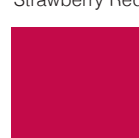

RAL3027
Raspberry Red

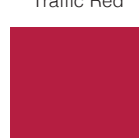

RAL3031
Orient Red

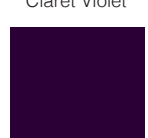

RAL4007
Purple Violet



RAL5024
Pastel Blue



RAL5007
Brilliant Blue



RAL5000
Violet Blue



RAL5009
Azure Blue



RAL5018
Turquoise Blue



RAL6001
Emerald Green



RAL5015
Sky Blue



RAL5023
Distant Blue



RAL5001
Green Blue



RAL5010
Gentian Blue



RAL5019
Capri Blue



RAL6002
Leaf Green



RAL5017
Traffic Blue



RAL5014
Pigeon Blue



RAL5002
Ultramarine Blue



RAL5011
Steele Blue



RAL5020
Ocean Blue



RAL6003
Olive Green



RAL5005
Signal Blue



RAL5012
Light Blue



RAL5003
Sapphire Blue



RAL5008
Grey Blue



RAL5021
Water Blue



RAL6004
Blue Green



RAL5013
Cobalt



RAL5022
Night Blue



RAL5004
Black Blue



RAL6000
Patina Green



RAL6034
Pastel Turquoise



RAL6005
Moss Green



RAL6007
Bottle Green



RAL6015
Black Olive



RAL6024
Traffic Green



RAL6027
Light Green



RAL6019
Pastel Green



RAL6028
Pine Green

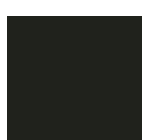

RAL6008
Brown Green



RAL6016
Turquoise Green



RAL6025
Fern Green



RAL6026
Opal Green



RAL6021
Pale Green



RAL6029
Mint Green



RAL6009
Fir Green

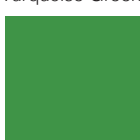

RAL6017
May Green



RAL6011
Reseda Green



RAL6013
Reed Green



RAL6020
Chrome Green



RAL6032
Signal Green



RAL6010
Grass Green

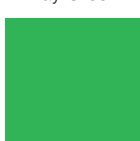

RAL6018
Yellow Green



RAL6012
Black Green



RAL6014
Yellow Olive

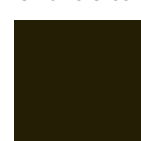

RAL6022
Olive Drab

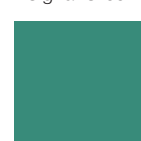

RAL6033
Mint Turquoise



RAL8015
Chestnut Brown



RAL8012
Red Brown



RAL8024
Beige Brown



RAL8023
Orange Brown



RAL8002
Signal Brown



RAL8017
Chocolate Brown



RAL8019
Grey Brown



RAL9004
Signal Black



RAL8008
Olive Brown



RAL8003
Clay Brown



RAL8000
Green Brown



RAL8004
Copper Brown



RAL8016
Mahogany Brown

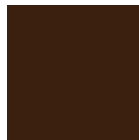

RAL8014
Sepia Brown



RAL8025
Pale Brown



RAL8001
Ocher Brown



RAL8007
Fawn Brown

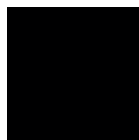

RAL8022
Black Brown



RAL9005
Jet Black



RAL9011
Graphite Black



RAL8011
Nut Brown



RAL8028
Terra Brown

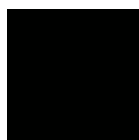





RAL9017
Traffic Black

Colors are reproduced with reasonable accuracy in standard Gloss finish unless noted Matte. If match is critical, contact us at 800-434-4610 for actual samples.

Standard Color Selections for Aluminum

Claridge offers the durability and brilliance of powder coat finishes for aluminum framed boards, mobile marker-boards cases, display cabinets and virtually any product offered with a metal or extruded aluminum component. Choose from any of the 24 standard colors shown below, or select from more than a 180 optional powder coat color examples inside – including textured and transparent finish choices.

					
RAL1013 Oyster White	RAL2009 Traffic Orange	RAL4001 Red Lilac	RAL5005 Signal Blue	RAL6005 Moss Green	RAL8017 Chocolate Brown
					
RAL1015 Light Ivory	RAL3003 Ruby Red	RAL4004 Claret Violet	RAL5013 Cobalt Blue	RAL6024 Traffic Green	RAL8025 Pale Brown
					
RAL1003 Signal Yellow	RAL3018 Strawberry Red	RAL5000 Violet Blue	RAL5015 Sky Blue	RAL7001 Silver Grey	RAL9003 Signal White
					
RAL1018 Zinc Yellow	RAL3020 Traffic Red	RAL5002 Ultramarine Blue	RAL6002 Leaf Green	RAL7015 Slate Grey	RAL9005 Jet Black

Optional Transparent Finishes					
	Aluminum Only	Transparent Green	Copper	Candy Red	Candy Teal

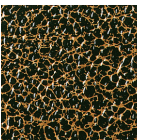
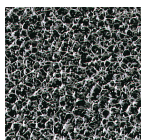
Optional Textured Finishes			
	Aluminum Only	PPLS98550 Antique Copper Vein	PES98116 Goldtone Vein



800.434.4610
claridgeproducts.com

Claridge®

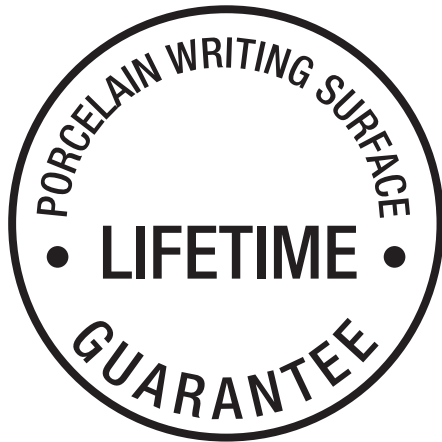

Under normal usage and maintenance, and when installed in accordance with manufacturer's instructions and recommendations, LCS Porcelain enamel steel markerboard and chalkboard writing surfaces are guaranteed for the Life of the Building.

Guarantee covers replacement of defective boards but does not include the cost of removal or re-installation.

SCS Global Services does hereby certify that an independent assessment has been conducted on behalf of:

Claridge Products & Equipment

480 Wrangler Drive, Suite 200, Coppell, TX, United States

For the following product(s):

See Addendum

The product(s) meet(s) all of the necessary qualifications to be certified for the following claim(s):

Indoor Advantage™ Gold

Indoor Air Quality Certified to SCS-EC10.3-2014 v4.1

Conforms to the ANSI/BIFMA Furniture Emissions Standard (M7.1/X7.1-2011 R2021) and ANSI/BIFMA e.3-2019 (Credits 7.6.1, 7.6.2, 7.6.3) for the open plan and private office workstation parameters.¹ Also, conforms to the CDPH/EHLB Standard Method (CA 01350) v1.2-2017 for the open plan and school classroom parameters.¹

¹ Modeled as Individual Furniture Components

Registration # SCS-IAQ-09072

Valid from: June 9, 2023 to June 8, 2024



INDOOR ADVANTAGE GOLD
FURNITURE



A handwritten signature in black ink that reads "Stanley Mathuram".

Stanley Mathuram, PE, Executive Vice President
SCS Global Services
2000 Powell Street, Ste. 600, Emeryville, CA 94608 USA

Certification Addendum

Claridge Products & Equipment

Certification: Registration # SCS-IAQ-09072 | Valid from: June 9, 2023 to June 8, 2024

Indoor Advantage™ Gold

Addendum Indoor Air Quality Certified to SCS-EC10.3-2014 v4.1

Conformance: Conforms to the ANSI/BIFMA Furniture Emissions Standard (M7.1/X7.1-2011 R2021) and ANSI/BIFMA e.3-2019 (Credits 7.6.1, 7.6.2, 7.6.3) for the open plan and private office workstation parameters.¹ Also, conforms to the CDPH/EHLB Standard Method (CA 01350) v1.2-2017 for the open plan and school classroom parameters.¹

¹ Modeled as Individual Furniture Components

Products: Visual Display Boards:

213 Series Tackboard with Wood Frame, 309 Sliding Door Display Case, 310 Wood Framed Bulletin Board Cabinet, 3300 Series Tackboard, 3400 Series Tackboard, 344 Wave Lectern, 370 Series Recessed Display Case, 390 Large Door Recessed Display Case, 700 Series Wood, 725 Folding Screen, 742 Freestanding Display Case, 748 Universal Display Case, 79 Hang-Tight Rail System, 800 Series Markerboard, 800 Series Tackboard, 800 Series Type BR/BL Combo Markerboard Tackboard, 900A Tackboard, 94 Combination Map Rail & Clip Strip, Aceno Room Divider Panels-Base, Aceno Storage Cart, Aceno Track System, Arise Marker Walls, Arise Markerboard, Aspire Markerboards, Claridge LCS Porcelain, Classic Series Bulletin Board Cabinet, Classic Series Display Case, Concept Markerboard, Concept Tackboard, Connect X2 3 Caster Mobile Markerboard, Connect X2 Combination Markerboard/Tackboard, Connect X2 Full Height Mobile Markerboard Procelain-Glass, Connect X2 Markerboard Porcelain-Glass, Connect X2 Partial Height Markerboard, Connect X2 Space Creator Porcelain-Cork-Fabric, Connect X2 Tackboard, Contemporary Series Bulletin Board Cabinet, Contemporary Series Bulletin Board Cabinet, Contemporary Style Laminate Lecture Unit, Contemporary Style Wood Lecture Unit, Contio Mobile Markerboard, CS Clip Strips, Cursive Board, Cursive One Markerboard-Tackboard, Custom Printed Glass Boards, Deluxe Series Bulletin Board Cabinet, Deluxe Series Revolving Two-sided Mobile Markerboard, Deluxe Two-sided Mobile Markerboard, Display Case-Cabinet, Economy and Deluxe Map & Display Rail,

Certification Addendum

Claridge Products & Equipment

Certification: Registration # SCS-IAQ-09072 | Valid from: June 9, 2023 to June 8, 2024

Indoor Advantage™ Gold

Addendum Indoor Air Quality Certified to SCS-EC10.3-2014 v4.1

Conformance: Conforms to the ANSI/BIFMA Furniture Emissions Standard (M7.1/X7.1-2011 R2021) and ANSI/BIFMA e.3-2019 (Credits 7.6.1, 7.6.2, 7.6.3) for the open plan and private office workstation parameters.¹ Also, conforms to the CDPH/EHLB Standard Method (CA 01350) v1.2-2017 for the open plan and school classroom parameters.¹

¹ Modeled as Individual Furniture Components

Products: Edify Mobile Markerboard, EDR Exhibit Rail, Envision Graphics Markerboard, Economy and Deluxe Map & Display Rail, Evolve Markerboard, Evolve Sliding System, Evolve Tackboard, EZ Fit Markerboard Panel, Framed Tackboard, Glass Marker Walls, Glass Markerboards, Horizontal Sliding Markerboards, Imperial Series Bulletin Board Cabinet, Large Contemporary Series Bulletin Board Cabinet, Large Format Glass Marker System, Large Format Porcelain Marker System, LCS Deluxe Combo Markerboard-Tackboard w/Wood frame, LCS Deluxe Markerboard-Aluminum Frame, LCS Deluxe Markerboard-Aluminum Frame No Map Rail, LCS Deluxe Markerboard-Wood Frame, LCS Elite Markerboard, LCS Select Markerboard, LCS Wall-Write Marker Wall, LCS-Glass Combo Boards, Magnetic Glass Markerboard, Magnetic Non-Glare Glass Markerboard, Marker Walls, Merit Series Markerboard, Mina Mobile, Mina Space Creator, MIX Biophilic Mobile, MIX Mobile Glass-Porcelain Markerboard, MIX Mobile Markerboard-Tackboard, MIX Wood Framed Markerboard, MIX Wood Framed Tackboard, MLC405 Presentation Easel, Motif Wood Frame Markerboard, Motif Wood Frame Tackboard, Nimbus Multi-Purpose Mobile, Non-Magnetic Non-Glare Glass Markerboard, Premier Wall Mounted Display Case, Premiere Freestanding Display Case, Premiere Series Reversible Mobile Markerboard w/ aluminum or wood trim, Profile Frameless LCS Porcelain Markerboard, Ravina Markerboard Glass-Porcelain, Ravina Tackboard Fabric-Acoustic, Revere Series Bulletin Board, Revere Series Bulletin Board Cabinet, Ripple Space Divider Acoustic-Acrylic, Series 1 Markerboard, Series 1 Tackboard, Series 1100 Wood Framed Markerboard, Series 1100 Wood Framed Markerboard, Series 1100 Wood Framed Tackboard, Series 2 Markerboard, Series 2 Tackboard,

Certification Addendum

Claridge Products & Equipment

Certification: Registration # SCS-IAQ-09072 | Valid from: June 9, 2023 to June 8, 2024

Indoor Advantage™ Gold

Addendum Indoor Air Quality Certified to SCS-EC10.3-2014 v4.1

Conformance: Conforms to the ANSI/BIFMA Furniture Emissions Standard (M7.1/X7.1-2011 R2021) and ANSI/BIFMA e.3-2019 (Credits 7.6.1, 7.6.2, 7.6.3) for the open plan and private office workstation parameters.¹ Also, conforms to the CDPH/EHLB Standard Method (CA 01350) v1.2-2017 for the open plan and school classroom parameters.¹

¹ Modeled as Individual Furniture Components

Products: Series 200 Markerboard, Series 200 Tackboard, Series 2000 Markerboard, Series 2000 Tackboard, Series 2100 Wood Framed Markerboard, Series 2100 Wood Framed Tackboard, Series 2500 Markerboard, Series 2900 Markerboard, Series 3 Markerboard, Series 3 Tackboard, Series 4 Markerboard, Series 4 Tackboard, Series 400 Markerboard, Series 400 Tackboard, Series 4000 Markerboard, Series 4000 Tackboard, Series 500 Markerboard, Series 500 Tackboard, Series 6000 Markerboard, Series 6000 Tackboard, Series 8 Markerboard, Series 8 Tackboard, Series 8000 Markerboard, Series 8000 Tackboard, Sliding Marker Wall Systems Porcelain-Glass, Switch Markerboard Porcelain-Glass, Switch Mobile Markerboard Porcelain-Glass, Tableau Markerboard Porcelain-Glass, Tableau Tackboard, Tack Wall, TacPads Acoustic Fabric-Wrapped, Trak-it-system, TrimLine Markerboard, Universal Series Bulletin Board Cabinet, Utility A-Frame Mobile Markerboard, Venue Markerboard Porcelain-Glass, Venue Space Divider Porcelain-Glass Acoustic, Venue T-Leg Mobile Markerboard porcelain-Glass, Venue V-Leg Mobile Markerboard Porcelain-Glass, Vertical Sliding Markerboards, WDR Wooden Display Rail, Wood Frame Bulletin Board Cabinet, Xchange Graphic Board

Excludes products manufactured with a cork substrate

Tackboard included are constructed with a fabricork or designer fabric over Duracore or Micore.