

# Claridge Glass

## Wall-Mounted Markerboard



Claridge Glass dry erase whiteboards are stylish, functional and easy to maintain. Made from low-iron, ultra-clear glass for exceptional clarity, Claridge Glass is available in 10 standard colors and over 180 optional powder coat colors, with three different mounting options.

- Ultra-clear Claridge Glass never stains or ghosts
- Three mounting options: Invisi-Mount, Standoff Edge or Standoff Through Glass Mounts
- Magnetic surface is great for tacking notes and collaboration
- Custom options and sizes available
- Claridge Glass is SCS Indoor Advantage Certified, eco-friendly, and emits no VOC's

# Claridge Glass

## Wall-Mounted Markerboard



### SPECIFICATIONS

- 1/4" low iron ultra clear glass
- Available in magnetic and non-magnetic glass
- Scratch and stain resistant
- 4 rare earth magnets included with each markerboard
- All mounting hardware included

### GLASS HIGHLIGHTS

- Bacteria resistant
- Premium writing surface
- Heavy material
- Reflective surface
- Magnetic option
- Lower contrast

***View Writing Surface Comparison [HERE](#)***

### COLORS

- 10 standard glass colors
- 180 optional glass colors
- Custom color matching available

***View Claridge Glass Colors [HERE](#)***

### CUSTOMIZE

- Custom shape and size available
- Custom logo and artwork print direct to glass

### MOUNTING STYLE OPTIONS

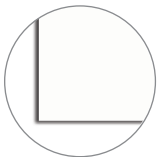

Invisi-mount

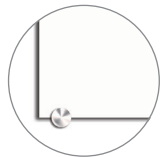

Standoff Edge Mount



Standoff Through Mount

### STANDARD SIZES (HxW)

5' x 4'	5' x 6'	5' x 8'	5' x 10'	
4' x 4'	4' x 6'	4' x 8'	4' x 10'	4' x 12'
3' x 4'				
2' x 3'				

**LEARN MORE**



800-434-4610  
claridgeproducts.com



## Glass Markerboard

Magnetic with  
Invisi-mount



### INSTALLATION INSTRUCTIONS

---

**Note:**

Number of dual-lock assemblies furnished varies with markerboard size.  
4' markerboards get 3 dual-lock sets; 6' size gets 4; 8' size gets 5.

Use caution when positioning glass markerboard panels next to each other. Because the weakest point of tempered glass is along the edges, edges should be protected as much as possible. Take care not to bump, rub, or grind edges together as fracturing may occur. Calyx will not be held responsible for damage caused by improper handling during installation.

*\*Dual lock is a registered trademark of 3M Corporation.*

**WARNING**

Risk of injury to installers and users  
Read the entire assembly directions before  
beginning assembly.

# Glass Markerboard with Invisi-mount

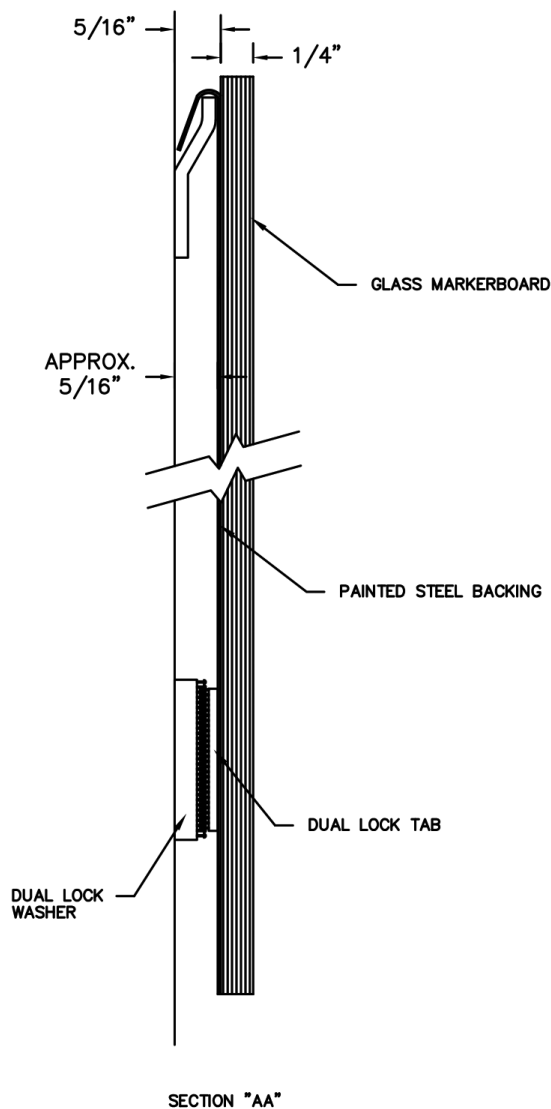

## INSTALLATION INSTRUCTIONS

1. Determine and mark desired height for mounting the magnetic glass markerboard
2. Measure down  $1 \frac{9}{16}$ " from designated height and strike a horizontal line for the bottom of the Z-bar.
3. Attach Z-bar hanger to wall using appropriate screws. Note: Slotted holes in hanger bar ensure easy alignment.
4. Position board on top of hanger and engage with hanger on back of glass markerboard.
5. Make a mark at bottom corners of glass markerboard and carefully remove board from wall.
6. Measure in and up approximately 2-to-3" from marked corners and install dual-lock 'disk' (washer) on wall using appropriate fastener. Press dual-lock strip (tab) firmly into disk on wall making sure mating is secure. (Dual-locks should be evenly spaced along the bottom of board).
7. Remove tape from assembly.
8. Reinstall markerboard, engaging hanger on back of markerboard with hanger on wall.
9. Press in at the bottom allowing the back of the glass markerboard to stick to the exposed adhesive on the hook and loop assembly.



800-434-4610  
claridgeproducts.com



## Glass Markerboard

Magnetic with  
Edge-mounts



### INSTALLATION INSTRUCTIONS

---



#### Parts List:

- Glass Markerboard
- Adjustable Edge Grip Stand-offs (number varies with board size)

#### Tools needed:

- Drill and Drill Bit
- Screwdriver
- Tape Measure and Level
- Hardware appropriate for wall installation

#### WARNING

Risk of injury to installers and users  
Read the entire assembly directions before  
beginning assembly.

# Glass Markerboard with Edge-mounts

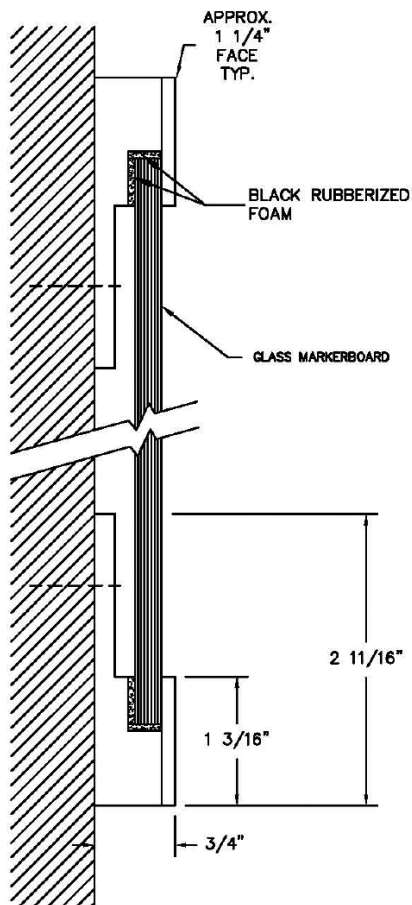

## INSTALLATION INSTRUCTIONS

1. Determine the desired height for the bottom of your glass markerboard.
2. Measure up 1-1/4" from desired height and strike a horizontal line.
3. Determine the length of your board and measure in 3" from both ends of the board and drill a hole for the edge grips. NOTE: Space evenly if more than four edge grips are furnished. (4' lengths and smaller are furnished with four edge grip stand-offs; 6' and 8' lengths are furnished with six: three for the top and three for the bottom.)
4. Fasten the edge grips to wall using fasteners appropriate for wall.
5. Determine top height of board, measure down 13/16" and strike a line, making sure line is level.
6. Install top edge grips following instructions in Step 3.
7. Raise adjustable edge grips at top up as high as possible.
8. Position glass board in groove of bottom edge grips and set in place.
9. Very gently tap top edge grips down until they are snug against the top of the board.
10. Make sure all edge grip stand-off caps are screwed on securely.

Note: MGM magnetic glass boards are furnished with rare earth magnets. Additional Magnetic Markerboard Accessories are optional.

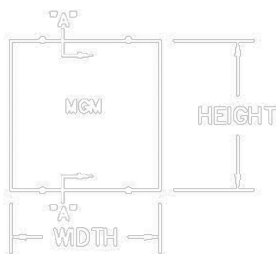

Claridge

800-434-4610  
claridgeproducts.com



# Glass Markerboard

Magnetic with  
Through-mounts

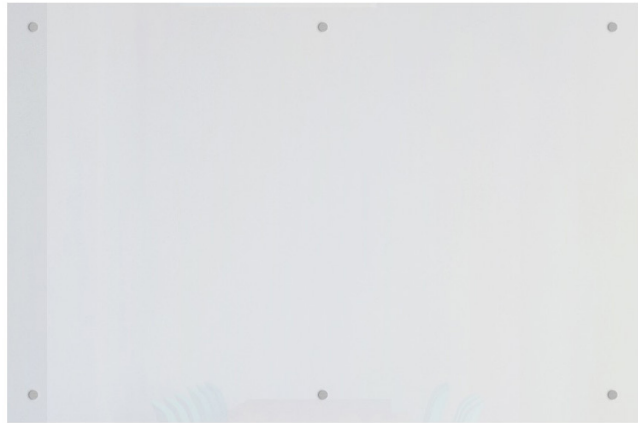

## INSTALLATION INSTRUCTIONS

---

### Parts List:

- Glass Markerboard
- Stand-offs (number varies with board size)

### Tools Needed

- Pencil
- Level
- Drill
- 2mm allen wrench

### WARNING

Risk of injury to installers and users  
Read the entire assembly directions before  
beginning assembly.

# Glass Markerboard with Through-mounts

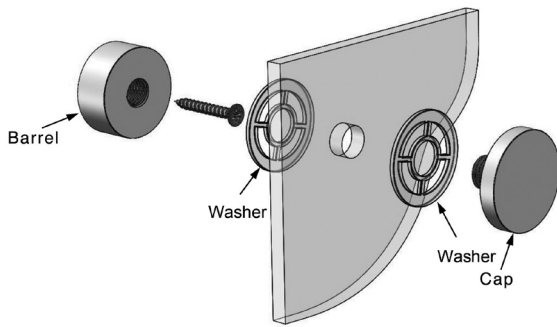
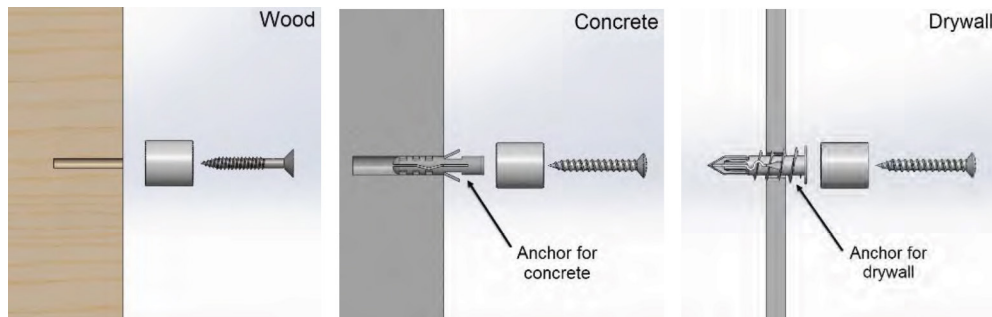

Figure 1

## INSTALLATION INSTRUCTIONS

1. Using a level, position the glass board on the wall, use the holes in the glass and mark their location on the wall.
2. Remove board from wall and pre-drill holes in center of circle.
3. Using appropriate screw, install the barrel of the standoffs, repeat for remaining standoffs. (We suggest you anchor into studs, if that is not an option, use fasteners appropriate for your wall type)
4. Make sure to position the barrel where the allen bolt is accessible after glass is installed. (see Figure 1)
5. Position glass centering holes on standoff barrel, making sure to add nylon washer to each side of glass.
6. Screw in cap. Once cap is tight, tighten allen bolts with 2 mm allen wrench.



*Always check the installation surface to ensure that the substrate will be strong enough to hold the weight of the panel. All installation must be done so with proper hardware and protective gears to ensure safety. It is important to check that parts are properly tightened at the end of each installation.*



800-434-4610  
claridgeproducts.com



### Standard Color Selections



Claridge Glass features an ultra clear writing surface that won't ghost or stain. An environmentally friendly process that offers 10 standard colors, 180 optional and unlimited custom colors for use on markerboards and walls.

- Works with standard dry-erase markers
- Doubles as a "tack" surface for use with magnetic accessories
- Resists humidity and fading
- SCS Indoor Advantage certified
- Eco-friendly, emits no VOCs

- Dry Erase markers can be wiped off using a standard eraser, microfiber eraser cloth or any dry cloth. Permanent markers may be removed using a standard glass cleaner.
- Periodic cleaning may be performed using glass cleaner. Avoid using abrasive type cleaners as they may dull or “pit” the surface of the glass.
- Always use a soft cloth, towel or microfiber cloth from Claridge to clean your Claridge Glass writing surface.
- Avoid cleaning glass if the surface is hot or in direct sunlight.
- Avoid leaving tape or other adhesives on your glass writing surface for long periods of time.

### Recommended Accessories:



#### Dry Erase Cloth

Product Code ECM227E - each  
ECM227D - 1 dozen

- 12”x12” Microfiber eraser cloth with a small magnet
- Erases cleanly with no smearing
- Reduces marker residue build-up



#### Magnetic Eraser

Product Code MGM-ME1

- Black felt eraser with strong rare earth magnets
- Measures 4-1/2” long, 2-1/8” wide and 7/8” thick



# POWDER COATINGS

## Color Guide



An environmentally friendly process that offers a wide range of decorative, functional colors for use on glass markerboards, walls, and metal frames.

### **BENEFITS OF POWDER COATING**

- More durable than baked enamels
- Delivers a brighter, smoother and cleaner finish
- Environmentally friendly, produces less hazardous waste than conventional liquid coatings
- Color choices are virtually unlimited with custom color matching

*Colors are reproduced with reasonable accuracy in standard Gloss finish unless noted Matte.  
If match is critical, contact us at 800-434-4610 for actual samples*



# Powder Coat Colors

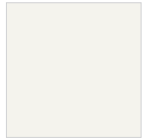

RAL9016  
Traffic White

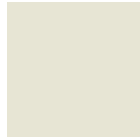

RAL9002  
Grey White



RAL9018  
Papyrus White



RAL7038  
Agate Grey



RAL7035  
Light Grey



RAL7044  
Silk Grey

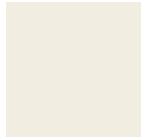

RAL9010  
Pure White

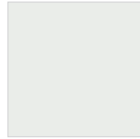

RAL9003  
Signal White

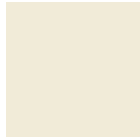

RAL9001  
Cream



RAL7047  
Telegrey 4



RAL7036  
Platinum Grey



RAL7045  
Telegrey 1



RAL7032  
Pebble Grey



RAL7033  
Cement Grey



RAL7042  
Traffic Grey A



RAL7004  
Signal Grey



RAL7046  
Telegrey 2



RAL7037  
Dusty Grey



RAL7030  
Stone Grey



RAL7034  
Yellow Grey



RAL7005  
Mouse Grey



RAL7040  
Window Grey



RAL7012  
Basalt Grey



RAL7043  
Traffic Grey B



RAL7003  
Moss Grey



RAL7013  
Brown Grey



RAL7039  
Quartz Grey



RAL7006  
Beige Grey



RAL7000  
Squirrel Grey



RAL7009  
Green Grey



RAL7001  
Silver Grey



RAL7010  
Tarpaulin Grey



RAL7023  
Concrete Grey



RAL7002  
Olive Grey



RAL7022  
Umbra Grey



RAL7011  
Iron Grey



RAL6006  
Grey Olive



RAL7008  
Khaki Grey



RAL7016  
Anthracite Grey



RAL7026  
Granite Grey



RAL7024  
Graphite Grey



RAL7021  
Black Grey



RAL1013  
Oyster White



RAL1015  
Light Ivory



RAL1014  
Ivory



RAL1000  
Green Beige



RAL1001  
Beige



RAL1011  
Brown Beige



RAL1002  
Sand Yellow



RAL1019  
Grey Beige



RAL1020  
Olive Yellow



RAL1024  
Ochre Yellow



RAL1027  
Curry



RAL1032  
Broom Yellow



RAL1021  
Yellow



RAL1018  
Zinc Yellow



RAL1033  
Dahlia Yellow



RAL2009  
Traffic Orange



RAL2004  
Pure Orange



RAL3004  
Purple Red



RAL1016  
Sulfur Yellow



RAL1012  
Lemon Yellow



RAL1034  
Pastel Yellow



RAL2010  
Signal Orange



RAL2008  
Bright Red Orange



RAL3005  
Wine Red



RAL1028  
Melon Yellow



RAL1023  
Traffic Yellow



RAL2000  
Yellow Orange



RAL2011  
Deep Orange



RAL3002  
Carmine Red



RAL3007  
Black Red



RAL1003  
Signal Yellow



RAL1017  
Saffron Yellow



RAL2001  
Red Orange



RAL2012  
Salmon Orange



RAL3003  
Ruby Red



RAL3009  
Oxide Red



RAL1004  
Golden Yellow



RAL1006  
Maize Yellow



RAL2002  
Vermilion



RAL3000  
Flame Red



RAL3013  
Tomato Red



RAL3011  
Brown Red



RAL1005  
Honey Yellow



RAL1007  
Daffodil Yellow



RAL2003  
Pastel Orange



RAL3001  
Signal Red



RAL3014  
Antique Pink



RAL3012  
Beige Red



RAL3015  
Light Pink

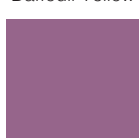

RAL4001  
Red Lilac



RAL4009  
Pastel Violet

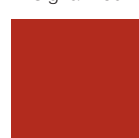

RAL3016  
Coral Red



RAL4002  
Red Violet

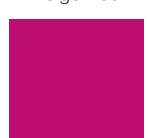

RAL4010  
Telemagenta



RAL4003  
Heather Violet



RAL4005  
Blue Lilac

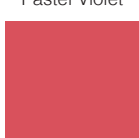

RAL3017  
Rose

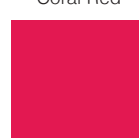

RAL3018  
Strawberry Red



RAL3020  
Traffic Red



RAL4004  
Claret Violet

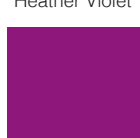

RAL4006  
Traffic Purple



RAL4008  
Signal Violet



RAL3022  
Salmon Pink

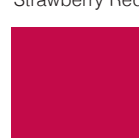

RAL3027  
Raspberry Red

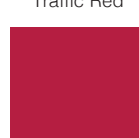

RAL3031  
Orient Red

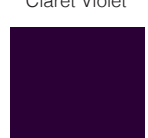

RAL4007  
Purple Violet



RAL5024  
Pastel Blue



RAL5007  
Brilliant Blue



RAL5000  
Violet Blue



RAL5009  
Azure Blue



RAL5018  
Turquoise Blue



RAL6001  
Emerald Green



RAL5015  
Sky Blue



RAL5023  
Distant Blue



RAL5001  
Green Blue



RAL5010  
Gentian Blue



RAL5019  
Capri Blue



RAL6002  
Leaf Green



RAL5017  
Traffic Blue



RAL5014  
Pigeon Blue



RAL5002  
Ultramarine Blue



RAL5011  
Steele Blue



RAL5020  
Ocean Blue



RAL6003  
Olive Green



RAL5005  
Signal Blue



RAL5012  
Light Blue



RAL5003  
Sapphire Blue



RAL5008  
Grey Blue



RAL5021  
Water Blue



RAL6004  
Blue Green



RAL5013  
Cobalt



RAL5022  
Night Blue



RAL5004  
Black Blue



RAL6000  
Patina Green



RAL6034  
Pastel Turquoise



RAL6005  
Moss Green



RAL6007  
Bottle Green



RAL6015  
Black Olive



RAL6024  
Traffic Green



RAL6027  
Light Green



RAL6019  
Pastel Green



RAL6028  
Pine Green

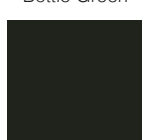

RAL6008  
Brown Green

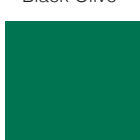

RAL6016  
Turquoise Green

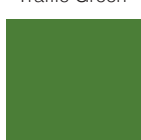

RAL6025  
Fern Green

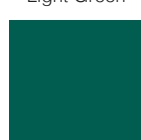

RAL6026  
Opal Green

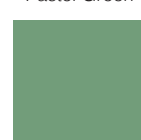

RAL6021  
Pale Green

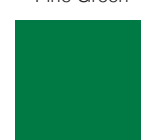

RAL6029  
Mint Green

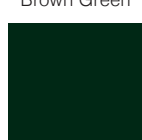

RAL6009  
Fir Green

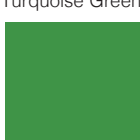

RAL6017  
May Green

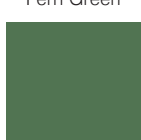

RAL6011  
Reseda Green

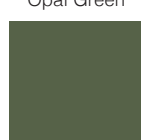

RAL6013  
Reed Green



RAL6020  
Chrome Green



RAL6032  
Signal Green



RAL6010  
Grass Green



RAL6018  
Yellow Green

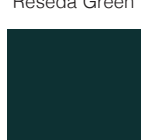

RAL6012  
Black Green

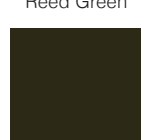

RAL6014  
Yellow Olive

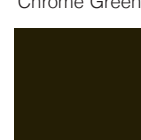

RAL6022  
Olive Drab



RAL6033  
Mint Turquoise



RAL8015  
Chestnut Brown



RAL8012  
Red Brown



RAL8024  
Beige Brown



RAL8023  
Orange Brown



RAL8002  
Signal Brown



RAL8017  
Chocolate Brown



RAL8019  
Grey Brown



RAL9004  
Signal Black



RAL8008  
Olive Brown



RAL8003  
Clay Brown



RAL8000  
Green Brown



RAL8004  
Copper Brown



RAL8016  
Mahogany Brown

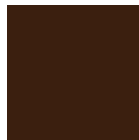

RAL8014  
Sepia Brown



RAL8025  
Pale Brown



RAL8001  
Ocher Brown



RAL8007  
Fawn Brown



RAL8022  
Black Brown



RAL9005  
Jet Black



RAL9011  
Graphite Black



RAL8011  
Nut Brown



RAL8028  
Terra Brown

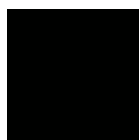





RAL9017  
Traffic Black

*Colors are reproduced with reasonable accuracy in standard Gloss finish unless noted Matte. If match is critical, contact us at 800-434-4610 for actual samples.*

# Standard Color Selections for Aluminum

Claridge offers the durability and brilliance of powder coat finishes for aluminum framed boards, mobile marker-boards cases, display cabinets and virtually any product offered with a metal or extruded aluminum component. Choose from any of the 24 standard colors shown below, or select from more than a 180 optional powder coat color examples inside – including textured and transparent finish choices.

					
RAL1013 Oyster White	RAL2009 Traffic Orange	RAL4001 Red Lilac	RAL5005 Signal Blue	RAL6005 Moss Green	RAL8017 Chocolate Brown
					
RAL1015 Light Ivory	RAL3003 Ruby Red	RAL4004 Claret Violet	RAL5013 Cobalt Blue	RAL6024 Traffic Green	RAL8025 Pale Brown
					
RAL1003 Signal Yellow	RAL3018 Strawberry Red	RAL5000 Violet Blue	RAL5015 Sky Blue	RAL7001 Silver Grey	RAL9003 Signal White
					
RAL1018 Zinc Yellow	RAL3020 Traffic Red	RAL5002 Ultramarine Blue	RAL6002 Leaf Green	RAL7015 Slate Grey	RAL9005 Jet Black

Optional Transparent Finishes					
	Aluminum Only	Transparent Green	Copper	Candy Red	Candy Teal

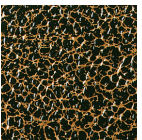
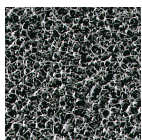
Optional Textured Finishes			
	Aluminum Only	PPLS98550 Antique Copper Vein	PES98116 Goldtone Vein



800.434.4610  
claridgeproducts.com





When properly installed in a suitable environment and under normal intended usage, care and maintenance, including the use of proper markers, erasers and cleaners; Claridge Glass markerboard writing surfaces are guaranteed for ten years.

This warranty excludes, among other things, any and all damages resulting from earth movements or any other natural and/or man-made disasters. We do not recommend the use of abrasive cleaners on the glass surface as they may dull or “pit” the surface of the glass. Guarantee covers replacement of defective surfaces but does not include damage to the edge of the glass board, cost of removal or re-installation.

SCS Global Services does hereby certify that an independent assessment has been conducted on behalf of:

# Claridge Products & Equipment

480 Wrangler Drive, Suite 200, Coppell, TX, United States

For the following product(s):

See Addendum

The product(s) meet(s) all of the necessary qualifications to be certified for the following claim(s):

## Indoor Advantage™ Gold

Indoor Air Quality Certified to SCS-EC10.3-2014 v4.1

Conforms to the ANSI/BIFMA Furniture Emissions Standard (M7.1/X7.1-2011 R2021) and ANSI/BIFMA e.3-2019 (Credits 7.6.1, 7.6.2, 7.6.3) for the open plan and private office workstation parameters.<sup>1</sup> Also, conforms to the CDPH/EHLB Standard Method (CA 01350) v1.2-2017 for the open plan and school classroom parameters.<sup>1</sup>

<sup>1</sup> Modeled as Individual Furniture Components

Registration # SCS-IAQ-09072

Valid from: June 9, 2023 to June 8, 2024



INDOOR ADVANTAGE GOLD  
FURNITURE



A handwritten signature in black ink that reads "Stanley Mathuram".

Stanley Mathuram, PE, Executive Vice President  
SCS Global Services  
2000 Powell Street, Ste. 600, Emeryville, CA 94608 USA

## **Certification Addendum**

# **Claridge Products & Equipment**

Certification: Registration # SCS-IAQ-09072 | Valid from: June 9, 2023 to June 8, 2024

### **Indoor Advantage™ Gold**

Addendum Indoor Air Quality Certified to SCS-EC10.3-2014 v4.1

Conformance: Conforms to the ANSI/BIFMA Furniture Emissions Standard (M7.1/X7.1-2011 R2021) and ANSI/BIFMA e.3-2019 (Credits 7.6.1, 7.6.2, 7.6.3) for the open plan and private office workstation parameters.<sup>1</sup> Also, conforms to the CDPH/EHLB Standard Method (CA 01350) v1.2-2017 for the open plan and school classroom parameters.<sup>1</sup>

<sup>1</sup> Modeled as Individual Furniture Components

#### **Products: Visual Display Boards:**

213 Series Tackboard with Wood Frame, 309 Sliding Door Display Case, 310 Wood Framed Bulletin Board Cabinet, 3300 Series Tackboard, 3400 Series Tackboard, 344 Wave Lectern, 370 Series Recessed Display Case, 390 Large Door Recessed Display Case, 700 Series Wood, 725 Folding Screen, 742 Freestanding Display Case, 748 Universal Display Case, 79 Hang-Tight Rail System, 800 Series Markerboard, 800 Series Tackboard, 800 Series Type BR/BL Combo Markerboard Tackboard, 900A Tackboard, 94 Combination Map Rail & Clip Strip, Aceno Room Divider Panels-Base, Aceno Storage Cart, Aceno Track System, Arise Marker Walls, Arise Markerboard, Aspire Markerboards, Claridge LCS Porcelain, Classic Series Bulletin Board Cabinet, Classic Series Display Case, Concept Markerboard, Concept Tackboard, Connect X2 3 Caster Mobile Markerboard, Connect X2 Combination Markerboard/Tackboard, Connect X2 Full Height Mobile Markerboard Procelain-Glass, Connect X2 Markerboard Porcelain-Glass, Connect X2 Partial Height Markerboard, Connect X2 Space Creator Porcelain-Cork-Fabric, Connect X2 Tackboard, Contemporary Series Bulletin Board Cabinet, Contemporary Series Bulletin Board Cabinet, Contemporary Style Laminate Lecture Unit, Contemporary Style Wood Lecture Unit, Contio Mobile Markerboard, CS Clip Strips, Cursive Board, Cursive One Markerboard-Tackboard, Custom Printed Glass Boards, Deluxe Series Bulletin Board Cabinet, Deluxe Series Revolving Two-sided Mobile Markerboard, Deluxe Two-sided Mobile Markerboard, Display Case-Cabinet, Economy and Deluxe Map & Display Rail,

## **Certification Addendum**

# **Claridge Products & Equipment**

Certification: Registration # SCS-IAQ-09072 | Valid from: June 9, 2023 to June 8, 2024

### **Indoor Advantage™ Gold**

Addendum Indoor Air Quality Certified to SCS-EC10.3-2014 v4.1

Conformance: Conforms to the ANSI/BIFMA Furniture Emissions Standard (M7.1/X7.1-2011 R2021) and ANSI/BIFMA e.3-2019 (Credits 7.6.1, 7.6.2, 7.6.3) for the open plan and private office workstation parameters.<sup>1</sup> Also, conforms to the CDPH/EHLB Standard Method (CA 01350) v1.2-2017 for the open plan and school classroom parameters.<sup>1</sup>

<sup>1</sup> Modeled as Individual Furniture Components

Products: Edify Mobile Markerboard, EDR Exhibit Rail, Envision Graphics Markerboard, Economy and Deluxe Map & Display Rail, Evolve Markerboard, Evolve Sliding System, Evolve Tackboard, EZ Fit Markerboard Panel, Framed Tackboard, Glass Marker Walls, Glass Markerboards, Horizontal Sliding Markerboards, Imperial Series Bulletin Board Cabinet, Large Contemporary Series Bulletin Board Cabinet, Large Format Glass Marker System, Large Format Porcelain Marker System, LCS Deluxe Combo Markerboard-Tackboard w/Wood frame, LCS Deluxe Markerboard-Aluminum Frame, LCS Deluxe Markerboard-Aluminum Frame No Map Rail, LCS Deluxe Markerboard-Wood Frame, LCS Elite Markerboard, LCS Select Markerboard, LCS Wall-Write Marker Wall, LCS-Glass Combo Boards, Magnetic Glass Markerboard, Magnetic Non-Glare Glass Markerboard, Marker Walls, Merit Series Markerboard, Mina Mobile, Mina Space Creator, MIX Biophilic Mobile, MIX Mobile Glass-Porcelain Markerboard, MIX Mobile Markerboard-Tackboard, MIX Wood Framed Markerboard, MIX Wood Framed Tackboard, MLC405 Presentation Easel, Motif Wood Frame Markerboard, Motif Wood Frame Tackboard, Nimbus Multi-Purpose Mobile, Non-Magnetic Non-Glare Glass Markerboard, Premier Wall Mounted Display Case, Premiere Freestanding Display Case, Premiere Series Reversible Mobile Markerboard w/ aluminum or wood trim, Profile Frameless LCS Porcelain Markerboard, Ravina Markerboard Glass-Porcelain, Ravina Tackboard Fabric-Acoustic, Revere Series Bulletin Board, Revere Series Bulletin Board Cabinet, Ripple Space Divider Acoustic-Acrylic, Series 1 Markerboard, Series 1 Tackboard, Series 1100 Wood Framed Markerboard, Series 1100 Wood Framed Markerboard, Series 1100 Wood Framed Tackboard, Series 2 Markerboard, Series 2 Tackboard,

## **Certification Addendum**

# **Claridge Products & Equipment**

Certification: Registration # SCS-IAQ-09072 | Valid from: June 9, 2023 to June 8, 2024

### **Indoor Advantage™ Gold**

Addendum Indoor Air Quality Certified to SCS-EC10.3-2014 v4.1

Conformance: Conforms to the ANSI/BIFMA Furniture Emissions Standard (M7.1/X7.1-2011 R2021) and ANSI/BIFMA e.3-2019 (Credits 7.6.1, 7.6.2, 7.6.3) for the open plan and private office workstation parameters.<sup>1</sup> Also, conforms to the CDPH/EHLB Standard Method (CA 01350) v1.2-2017 for the open plan and school classroom parameters.<sup>1</sup>

<sup>1</sup> Modeled as Individual Furniture Components

Products: Series 200 Markerboard, Series 200 Tackboard, Series 2000 Markerboard, Series 2000 Tackboard, Series 2100 Wood Framed Markerboard, Series 2100 Wood Framed Tackboard, Series 2500 Markerboard, Series 2900 Markerboard, Series 3 Markerboard, Series 3 Tackboard, Series 4 Markerboard, Series 4 Tackboard, Series 400 Markerboard, Series 400 Tackboard, Series 4000 Markerboard, Series 4000 Tackboard, Series 500 Markerboard, Series 500 Tackboard, Series 6000 Markerboard, Series 6000 Tackboard, Series 8 Markerboard, Series 8 Tackboard, Series 8000 Markerboard, Series 8000 Tackboard, Sliding Marker Wall Systems Porcelain-Glass, Switch Markerboard Porcelain-Glass, Switch Mobile Markerboard Porcelain-Glass, Tableau Markerboard Porcelain-Glass, Tableau Tackboard, Tack Wall, TacPads Acoustic Fabric-Wrapped, Trak-it-system, TrimLine Markerboard, Universal Series Bulletin Board Cabinet, Utility A-Frame Mobile Markerboard, Venue Markerboard Porcelain-Glass, Venue Space Divider Porcelain-Glass Acoustic, Venue T-Leg Mobile Markerboard porcelain-Glass, Venue V-Leg Mobile Markerboard Porcelain-Glass, Vertical Sliding Markerboards, WDR Wooden Display Rail, Wood Frame Bulletin Board Cabinet, Xchange Graphic Board

*Excludes products manufactured with a cork substrate*

*Tackboard included are constructed with a fabricork or designer fabric over Duracore or Micore.*