

Claridge Glass

Marker Wall



Claridge Glass Marker Walls offer a room-size presentation surface designed for heavy use and multiple-format presentations. Cover an entire wall, floor-to-ceiling, up to 10' and utilize all available space. Available in full or partial height.

- Ultra-clear Claridge Glass never stains or ghosts
- Magnetic tempered safety glass with a full steel backer
- Stand alone or group together
- Claridge Glass is SCS Indoor Advantage certified, eco-friendly, and emits no VOC's

Claridge Glass

Marker Wall



SPECIFICATIONS

- Glass panels can be combined to fit any width
- Narrow 1/4" satin anodized trim, top and bottom, available in 24 standard colors, 180 optional colors, and unlimited custom colors
- Claridge Glass is SCS Indoor Advantage certified, eco-friendly, and emits no VOC's

GLASS HIGHLIGHTS

- Bacteria resistant
- Premium writing surface
- Heavy material
- Reflective surface
- Magnetic option
- Lower contrast

View Writing Surface Comparison [HERE](#)

COLORS

- 10 standard glass colors
- 180 optional glass colors
- Custom color matching available

View Claridge Glass Colors [HERE](#)

LEARN MORE



800-434-4610
claridgeproducts.com



Claridge Glass Marker Wall

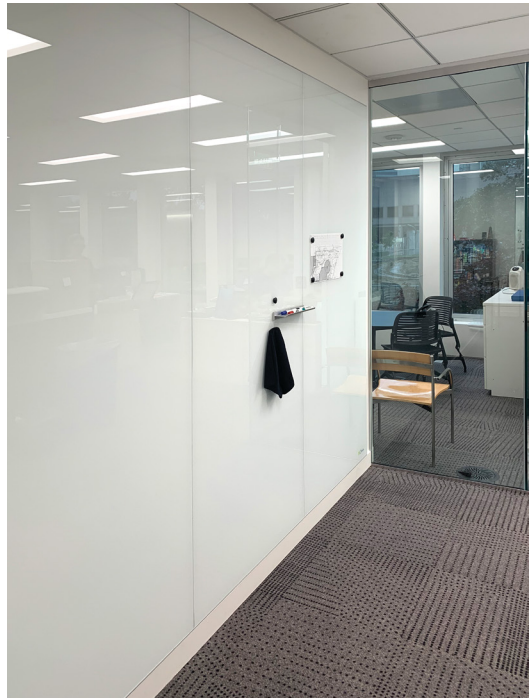

INSTALLATION INSTRUCTIONS

GLASS MARKER WALL

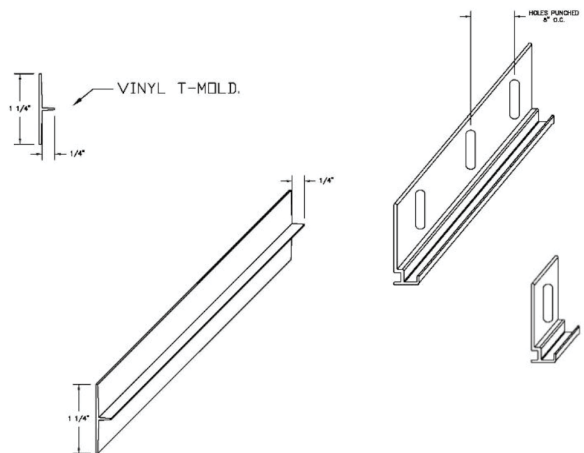
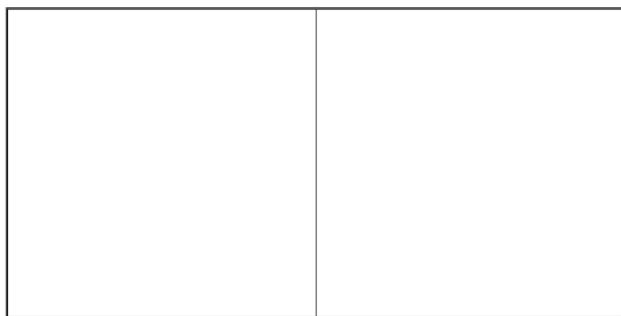

WARNING
Risk of injury to installers and users
Read the entire assembly directions before
beginning assembly.

Claridge Glass Marker Wall

INSTALLATION

1. Inspect product.
2. Cut trim to desired length based on number of panels to be installed.
3. Strike a level line marking position of bottom of glass panels.
4. Secure bottom trim to wall with appropriate screws and anchors making sure trim is level.
5. When installing the top trim, measure up from the bottom of the bottom trim the full height of the glass plus 1/8" and make it a level line. With the top edge of the trim on the line, drill in the center of each slot.
6. Fasten top trim to wall (push trim all the way up and snug securely). Do not over tighten because trim will be tapped down when glass is installed. Use a straight edge to check for flatness.
7. Apply adhesive to back of glass in globs about the size of a golf ball in a 12" grid pattern.
8. Place glass in bottom track then tap down the top trim to hold the glass. (If installing multiple panels, make sure the top trim isn't so low it prevents the next panel from sliding into place.)
9. If using the plastic t-mold between the glass panels cut it to desired length and apply adhesive on the backside of the strip. Repeat steps 7 and 8.

Note: If plastic t-mold is not used in the installation, we recommend using it to protect the edge of the glass while it is being moved into position. Place the t-mold in backwards between the glass panels, slide the panels together, pull the t-mold out and gently move the glass into its final position.

10. To insure a flush joint panels should be braced while adhesive is drying.

NOTE: Glass boards installed horizontally can be installed using 1191 clips in lieu of full length 1191 trim. Clips are pre-punched and installation steps would be the same as above. Clips should be evenly placed approx. 12 to 16" apart – top and bottom, starting 3 to 4" in from each end on individual glass panels. Clips are not recommended for glass panels mounted vertically.



Standard Color Selections



Claridge Glass features an ultra clear writing surface that won't ghost or stain. An environmentally friendly process that offers 10 standard colors, 180 optional and unlimited custom colors for use on markerboards and walls.

- Works with standard dry-erase markers
- Doubles as a "tack" surface for use with magnetic accessories
- Resists humidity and fading
- SCS Indoor Advantage certified
- Eco-friendly, emits no VOCs

- Dry Erase markers can be wiped off using a standard eraser, microfiber eraser cloth or any dry cloth. Permanent markers may be removed using a standard glass cleaner.
- Periodic cleaning may be performed using glass cleaner. Avoid using abrasive type cleaners as they may dull or “pit” the surface of the glass.
- Always use a soft cloth, towel or microfiber cloth from Claridge to clean your Claridge Glass writing surface.
- Avoid cleaning glass if the surface is hot or in direct sunlight.
- Avoid leaving tape or other adhesives on your glass writing surface for long periods of time.

Recommended Accessories:



Dry Erase Cloth

Product Code ECM227E - each
ECM227D - 1 dozen

- 12”x12” Microfiber eraser cloth with a small magnet
- Erases cleanly with no smearing
- Reduces marker residue build-up



Magnetic Eraser

Product Code MGM-ME1

- Black felt eraser with strong rare earth magnets
- Measures 4-1/2” long, 2-1/8” wide and 7/8” thick



POWDER COATINGS

Color Guide



An environmentally friendly process that offers a wide range of decorative, functional colors for use on glass markerboards, walls, and metal frames.

BENEFITS OF POWDER COATING

- More durable than baked enamels
- Delivers a brighter, smoother and cleaner finish
- Environmentally friendly, produces less hazardous waste than conventional liquid coatings
- Color choices are virtually unlimited with custom color matching

*Colors are reproduced with reasonable accuracy in standard Gloss finish unless noted Matte.
If match is critical, contact us at 800-434-4610 for actual samples*



Powder Coat Colors

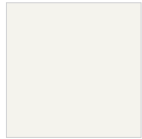

RAL9016
Traffic White

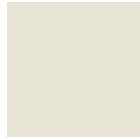

RAL9002
Grey White



RAL9018
Papyrus White



RAL7038
Agate Grey



RAL7035
Light Grey



RAL7044
Silk Grey

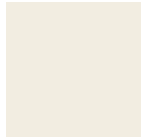

RAL9010
Pure White

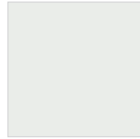

RAL9003
Signal White

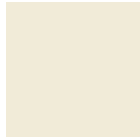

RAL9001
Cream



RAL7047
Telegrey 4



RAL7036
Platinum Grey



RAL7045
Telegrey 1



RAL7032
Pebble Grey



RAL7033
Cement Grey



RAL7042
Traffic Grey A



RAL7004
Signal Grey



RAL7046
Telegrey 2



RAL7037
Dusty Grey



RAL7030
Stone Grey



RAL7034
Yellow Grey



RAL7005
Mouse Grey



RAL7040
Window Grey



RAL7012
Basalt Grey



RAL7043
Traffic Grey B



RAL7003
Moss Grey



RAL7013
Brown Grey



RAL7039
Quartz Grey



RAL7006
Beige Grey



RAL7000
Squirrel Grey



RAL7009
Green Grey



RAL7001
Silver Grey



RAL7010
Tarpaulin Grey



RAL7023
Concrete Grey



RAL7002
Olive Grey



RAL7022
Umbra Grey



RAL7011
Iron Grey



RAL6006
Grey Olive



RAL7008
Khaki Grey



RAL7016
Anthracite Grey



RAL7026
Granite Grey



RAL7024
Graphite Grey



RAL7021
Black Grey



RAL1013
Oyster White



RAL1015
Light Ivory



RAL1014
Ivory



RAL1000
Green Beige



RAL1001
Beige



RAL1011
Brown Beige



RAL1002
Sand Yellow



RAL1019
Grey Beige



RAL1020
Olive Yellow



RAL1024
Ochre Yellow



RAL1027
Curry



RAL1032
Broom Yellow



RAL1021
Yellow



RAL1018
Zinc Yellow



RAL1033
Dahlia Yellow



RAL2009
Traffic Orange



RAL2004
Pure Orange



RAL3004
Purple Red



RAL1016
Sulfur Yellow



RAL1012
Lemon Yellow



RAL1034
Pastel Yellow



RAL2010
Signal Orange



RAL2008
Bright Red Orange



RAL3005
Wine Red



RAL1028
Melon Yellow



RAL1023
Traffic Yellow



RAL2000
Yellow Orange



RAL2011
Deep Orange



RAL3002
Carmine Red



RAL3007
Black Red



RAL1003
Signal Yellow



RAL1017
Saffron Yellow



RAL2001
Red Orange



RAL2012
Salmon Orange



RAL3003
Ruby Red



RAL3009
Oxide Red



RAL1004
Golden Yellow



RAL1006
Maize Yellow



RAL2002
Vermilion



RAL3000
Flame Red



RAL3013
Tomato Red



RAL3011
Brown Red



RAL1005
Honey Yellow



RAL1007
Daffodil Yellow



RAL2003
Pastel Orange



RAL3001
Signal Red



RAL3014
Antique Pink



RAL3012
Beige Red



RAL3015
Light Pink



RAL4001
Red Lilac



RAL4009
Pastel Violet



RAL3016
Coral Red



RAL4002
Red Violet



RAL4010
Telemagenta

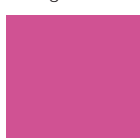

RAL4003
Heather Violet



RAL4005
Blue Lilac



RAL3017
Rose



RAL3018
Strawberry Red



RAL3020
Traffic Red



RAL4004
Claret Violet

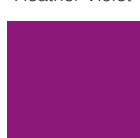

RAL4006
Traffic Purple



RAL4008
Signal Violet

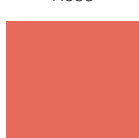

RAL3022
Salmon Pink



RAL3027
Raspberry Red



RAL3031
Orient Red



RAL4007
Purple Violet



RAL5024
Pastel Blue



RAL5007
Brilliant Blue



RAL5000
Violet Blue



RAL5009
Azure Blue



RAL5018
Turquoise Blue



RAL6001
Emerald Green



RAL5015
Sky Blue



RAL5023
Distant Blue



RAL5001
Green Blue



RAL5010
Gentian Blue



RAL5019
Capri Blue



RAL6002
Leaf Green



RAL5017
Traffic Blue



RAL5014
Pigeon Blue



RAL5002
Ultramarine Blue



RAL5011
Steele Blue



RAL5020
Ocean Blue



RAL6003
Olive Green



RAL5005
Signal Blue



RAL5012
Light Blue



RAL5003
Sapphire Blue



RAL5008
Grey Blue



RAL5021
Water Blue



RAL6004
Blue Green



RAL5013
Cobalt



RAL5022
Night Blue



RAL5004
Black Blue



RAL6000
Patina Green



RAL6034
Pastel Turquoise



RAL6005
Moss Green



RAL6007
Bottle Green

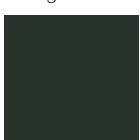

RAL6015
Black Olive



RAL6024
Traffic Green



RAL6027
Light Green



RAL6019
Pastel Green



RAL6028
Pine Green

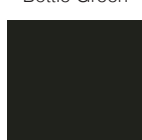

RAL6008
Brown Green

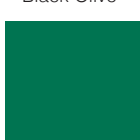

RAL6016
Turquoise Green

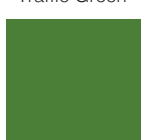

RAL6025
Fern Green

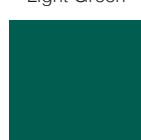

RAL6026
Opal Green

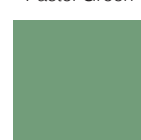

RAL6021
Pale Green

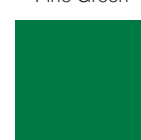

RAL6029
Mint Green

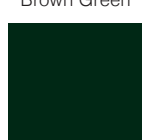

RAL6009
Fir Green



RAL6017
May Green

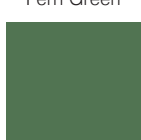

RAL6011
Reseda Green

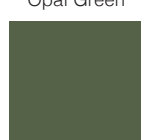

RAL6013
Reed Green

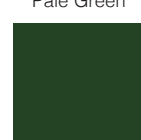

RAL6020
Chrome Green



RAL6032
Signal Green



RAL6010
Grass Green



RAL6018
Yellow Green

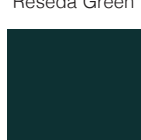

RAL6012
Black Green

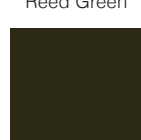

RAL6014
Yellow Olive

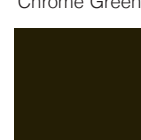

RAL6022
Olive Drab



RAL6033
Mint Turquoise



RAL8015
Chestnut Brown



RAL8012
Red Brown

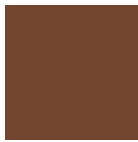

RAL8024
Beige Brown



RAL8023
Orange Brown



RAL8002
Signal Brown



RAL8017
Chocolate Brown



RAL8019
Grey Brown



RAL9004
Signal Black



RAL8008
Olive Brown



RAL8003
Clay Brown



RAL8000
Green Brown



RAL8004
Copper Brown

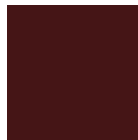

RAL8016
Mahogany Brown

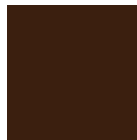

RAL8014
Sepia Brown



RAL8025
Pale Brown



RAL8001
Ocher Brown



RAL8007
Fawn Brown

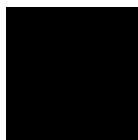

RAL8022
Black Brown



RAL9005
Jet Black



RAL9011
Graphite Black



RAL8011
Nut Brown



RAL8028
Terra Brown

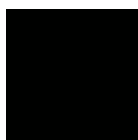





RAL9017
Traffic Black

Colors are reproduced with reasonable accuracy in standard Gloss finish unless noted Matte. If match is critical, contact us at 800-434-4610 for actual samples.

Standard Color Selections for Aluminum

Claridge offers the durability and brilliance of powder coat finishes for aluminum framed boards, mobile marker-boards cases, display cabinets and virtually any product offered with a metal or extruded aluminum component. Choose from any of the 24 standard colors shown below, or select from more than a 180 optional powder coat color examples inside – including textured and transparent finish choices.

					
RAL1013 Oyster White	RAL2009 Traffic Orange	RAL4001 Red Lilac	RAL5005 Signal Blue	RAL6005 Moss Green	RAL8017 Chocolate Brown
					
RAL1015 Light Ivory	RAL3003 Ruby Red	RAL4004 Claret Violet	RAL5013 Cobalt Blue	RAL6024 Traffic Green	RAL8025 Pale Brown
					
RAL1003 Signal Yellow	RAL3018 Strawberry Red	RAL5000 Violet Blue	RAL5015 Sky Blue	RAL7001 Silver Grey	RAL9003 Signal White
					
RAL1018 Zinc Yellow	RAL3020 Traffic Red	RAL5002 Ultramarine Blue	RAL6002 Leaf Green	RAL7015 Slate Grey	RAL9005 Jet Black

Optional Transparent Finishes					
	Aluminum Only	Transparent Green	Copper	Candy Red	Candy Teal

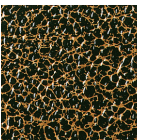
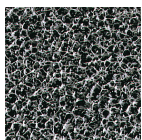
Optional Textured Finishes			
	Aluminum Only	PPLS98550 Antique Copper Vein	PES98116 Goldtone Vein



800.434.4610
claridgeproducts.com

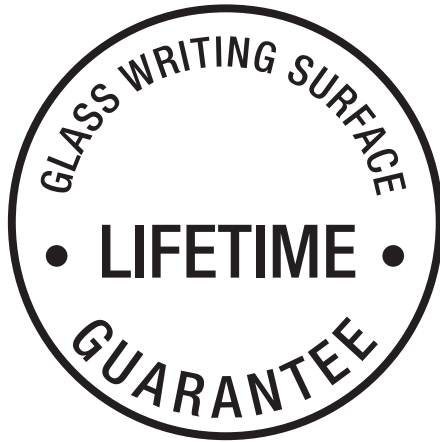

When properly installed in a suitable environment and under normal intended usage, care and maintenance, including the use of proper markers, erasers and cleaners; Claridge Glass markerboard writing surfaces are guaranteed for the Life of the Building.

This warranty excludes, among other things, any and all damages resulting from earth movements or any other natural and/or man-made disasters. We do not recommend the use of abrasive cleaners on the glass surface as they may dull or “pit” the surface of the glass. Guarantee covers replacement of defective surfaces but does not include damage to the edge of the glass board, cost of removal or re-installation.

SCS Global Services does hereby certify that an independent assessment has been conducted on behalf of:

Claridge Products & Equipment

480 Wrangler Drive
Suite 200, Coppell, 75019, United States

For the following product(s):

See Addendum

The product(s) meet(s) all of the necessary qualifications to be certified for the following claim(s):

Indoor Advantage™ Gold

Indoor Air Quality Certified to SCS-105 v4.2

Conforms to the ANSI/BIFMA Furniture Emissions Standard (M7.1/X7.1-2011 R2021) and ANSI/BIFMA e.3-2019 (Credits 7.6.2, 7.6.3) for the open plan and (Credits 7.6.1, 7.6.2, 7.6.3) private office workstation parameters.¹ Also, conforms to the CDPH/EHLB Standard Method (CA 01350) v1.2-2017 for the open plan and school classroom parameters.¹

¹Modeled as Individual Furniture Components

Registration # SCS-IAQ-09072

Valid from: November 04, 2024 to June 08, 2025



INDOOR ADVANTAGE GOLD
FURNITURE



ANSI National Accreditation Board
ACCREDITED

ISO/IEC 17065
PRODUCT CERTIFICATION
BODY



Diana Kirsanova Phillips, Chief Assurance
Officer,
SCS Global Services

Certification Addendum

Claridge Products & Equipment

Certification: Registration # SCS-IAQ-09072 | Valid from: November 04, 2024 to June 08, 2025

Addendum Indoor Advantage™ Gold

Conformance: Indoor Air Quality Certified to SCS-105 v4.2

Conforms to the ANSI/BIFMA Furniture Emissions Standard (M7.1/X7.1-2011 R2021) and ANSI/BIFMA e.3-2019 (Credits 7.6.2, 7.6.3) for the open plan and (Credits 7.6.1, 7.6.2, 7.6.3) private office workstation parameters.¹ Also, conforms to the CDPH/EHLB Standard Method (CA 01350) v1.2-2017 for the open plan and school classroom parameters.¹

¹Modeled as Individual Furniture Components

Products:

Visual Display Boards:

3300 Series Tackboard, 3400 Series Tackboard, 344 Wave Lectern, 370 Series Recessed Display Case, 390 Large Door Recessed Display Case, 725 Folding Screen, 748 Universal Display Case, 79 Hang-Tight Rail System, 800 Series Markerboard, 800 Series Tackboard, 800 Series Type BR/BL Combo Markerboard Tackboard, 900A Tackboard, 94 Combination Map Rail & Clip Strip, Aceno Room Divider Panels-Base, Aceno Track System, Arise Marker Walls, Arise Markerboard, Aspire Markerboards, Claridge LCS Porcelain, Classic Series Bulletin Board Cabinet, Classic Series Display Case, Concept Markerboard, Concept Tackboard, Connect X2 3 Caster Mobile Markerboard, Connect X2 Combination Markerboard/Tackboard, Connect X2 Full Height Mobile Markerboard Porcelain-Glass, Connect X2 Markerboard Porcelain-Glass, Connect X2 Partial Height Markerboard, Connect X2 Space Creator Porcelain-Cork-Fabric, Connect X2 Tackboard, Contemporary Series Bulletin Board Cabinet, Contemporary Series Bulletin Board Cabinet, Contemporary Style Laminate Lecture Unit, Contio Mobile Markerboard, CS Clip Strips, Cursive Board, Cursive One Markerboard-Tackboard, Custom Printed Glass Boards, Deluxe Series Bulletin Board Cabinet, Deluxe Series Revolving Two-sided Mobile Markerboard, Deluxe Two-sided Mobile Markerboard, Display Case-Cabinet, Economy and Deluxe Map & Display Rail, Edify Mobile Markerboard, EDR Exhibit Rail, Envision Graphics Markerboard, Economy and Deluxe Map & Display Rail, Evolve Markerboard, Evolve Sliding System, Evolve Tackboard, EZ Fit Markerboard Panel, Framed Tackboard, Glass Marker Walls, Glass Markerboards, Horizontal Sliding Markerboards, Imperial Series Bulletin Board Cabinet, Large Contemporary Series Bulletin Board Cabinet, Large Format Glass Marker System, Large Format Porcelain Marker System, LCS Deluxe Markerboard-Aluminum Frame,

Certification Addendum **Claridge Products & Equipment**

Certification: Registration # SCS-IAQ-09072 | Valid from: November 04, 2024 to June 08, 2025

Addendum **Indoor Advantage™ Gold**

Conformance: Indoor Air Quality Certified to SCS-105 v4.2

Conforms to the ANSI/BIFMA Furniture Emissions Standard (M7.1/X7.1-2011 R2021) and ANSI/BIFMA e.3-2019 (Credits 7.6.2, 7.6.3) for the open plan and (Credits 7.6.1, 7.6.2, 7.6.3) private office workstation parameters.¹ Also, conforms to the CDPH/EHLB Standard Method (CA 01350) v1.2-2017 for the open plan and school classroom parameters.¹

¹Modeled as Individual Furniture Components

Products:

Visual Display Boards Continued:

LCS Deluxe Markerboard-Aluminum Frame No Map Rail, LCS Deluxe Markerboard-Wood Frame, LCS Elite Markerboard, LCS Select Markerboard, LCS Wall-Write Marker Wall, LCS-Glass Combo Boards, Magnetic Glass Markerboard, Magnetic Non-Glare Glass Markerboard, Marker Walls, Merit Series Markerboard, Mina Mobile, Mina Space Creator, Non-Magnetic Non-Glare Glass Markerboard, Premier Wall Mounted Display Case, Premiere Freestanding Display Case, Premiere Series Reversible Mobile Markerboard w/ aluminum trim, Profile Frameless LCS Porcelain Markerboard, Revere Series Bulletin Board, Revere Series Bulletin Board Cabinet, Ripple Space Divider Acoustic-Acrylic, Series 1 Markerboard, Series 1 Tackboard, Series 5 Markerboard, Series 5 Tackboard, Series 2 Markerboard, Series 2 Tackboard, Series 2500 Markerboard, Series 3 Markerboard, Series 3 Tackboard, Series 4 Markerboard, Series 4 Tackboard, Series 8 Markerboard, Series 8 Tackboard, Sliding Marker Wall Systems Porcelain-Glass, Switch Markerboard Porcelain-Glass, Switch Mobile Markerboard Porcelain-Glass, Tableau Markerboard Porcelain-Glass, Tableau Tackboard, Tack Wall, TacPads Acoustic Fabric-Wrapped, Trak-it-system, TrimLine Markerboard, Universal Series Bulletin Board Cabinet, Utility A-Frame Mobile Markerboard, Venue Markerboard Porcelain-Glass, Venue Space Divider Porcelain-Glass Acoustic, Venue T-Leg Mobile Markerboard porcelain-Glass, Venue V-Leg Mobile Markerboard Porcelain-Glass, Vertical Sliding Markerboards, Xchange Graphic Board

Excludes products with wood trim. Excludes products manufactured with a cork substrate. Tackboard included are constructed with a fabricork or designer fabric over Duracore or Micore.