

# Horizontal Sliding System

## Wall-Mounted Sliding Boards

Claridge



Horizontal Sliding Units are custom-built to meet your needs, providing optimum display surfaces within easy reach for teaching, conferences, and training. The sliding panels and back panels can be Claridge LCS Porcelain dry erase markerboard or chalkboard. Also, Claridge Cork, Fabricork, Guilford of Maine FR701 Fabric, and Tan Nucork tackboard surfaces, along with projection screen, or COM fabrics can be applied to any of these panels.

- Claridge LCS Porcelain sliding panels and back panel
- Top-suspended sliding panels glide easily over an aluminum track on nylon rollers
- Magnetic surface
- Resists humidity and fading

# Horizontal Sliding System

## Wall-Mounted Sliding Boards

---



### SPECIFICATIONS

- Sliding panels glide easily over an aluminum track on molded nylon rollers
- Fixed back panel with 2, 3, or 4 sliding panels and tracks
- Back panels can also be eliminated for “pass through” application
- Sizes available from 4' x 6' up to 4' x 24'

### Claridge LCS Porcelain

- Projection friendly surface that won't ghost or stain
- Accepts magnetic accessories
- LCS Porcelain is SCS Indoor Advantage Gold certified, eco-friendly, and emits no VOC's
- Lifetime warranty

[View Porcelain Highlights HERE](#)

### COLORS

- 3 markerboard colors
- 3 chalkboard colors

[View Claridge LCS Porcelain Colors HERE](#)

### Tackable Surfaces

Tackboard fabrics are offered in Claridge Cork, Fabricork, Tan Nucork as well as a wide range of contemporary patterns from Guilford of Maine.

[View Tackable Surface Options HERE](#)

[LEARN MORE](#)



800-434-4610  
[claridgeproducts.com](http://claridgeproducts.com)

V072723



## Horizontal Sliding Unit Wall-Mounted Boards



### INSTALLATION INSTRUCTIONS

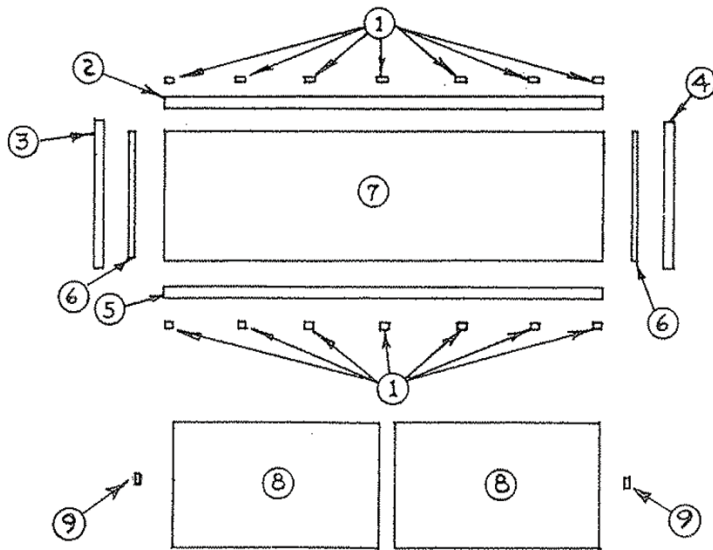

#### Parts Layout Identification

1. 2" Mounting Clips 16" O.C. top and bottom
2. Head housing with map rail
3. Left jamb housing
4. Right jamb housing
5. Sill housing with chalk trough
6. Back panel jamb trim - No sill or head trim required for back panel
7. Fixed back panel - Mount to wall
8. Sliding panels
9. Finger pulls

#### WARNING

Risk of injury to installers and users  
Read the entire assembly directions before beginning assembly.

# Horizontal Sliding Unit Wall-Mounted Boards

## Installation Instructions

1. Lay out and identify all parts.
2. Using the 2-1/2" pan head screws furnished, fasten top and bottom clips to wall on 16" centers being sure clips are level.
3. Slide rollers onto tracks in top member. Be sure openings in rollers on front track face to the rear and openings for rollers on all other tracks face forward. (On 3 or 4 track units, rollers on tracks 1 and 3 must face to the rear.)
4. Install fixed back panel to wall with egg-sized globs of adhesive 16" on centers. The clearance between the back panel and sliding panel is close. Be sure not to get too much adhesive or allow the back panel to stick out any farther from the wall than necessary. We recommend using screw - in addition to the adhesive - along top and bottom of back panel. (Screws furnished.) 1/8" clearance is allowed at top, bottom, and sides of fixed back panel. Install back panel jamb trim members. No head or sill trim is required.
5. Fasten right and left hand jamb housing members to top and bottom members with 1/2" pan head screws provided.
6. Position complete frame onto hanger clips previously screwed to wall in step 2.
7. Drill 9/64" diameter holes through into clips at top and bottom. Secure frame to clips with 1/2" pan head screws provided.
8. Position sliding panels in unit by inserting top of panel between tracks and moving it up as far as possible. Tilt bottom of panel into guide channel and let panel rest on lower housing.
9. Slide rollers over hooks in panel. Lift panel and slide hooks into opening in rollers. Tighten nut on rollers to roller assembly.
10. Install finger pulls, two per panel, on sliding panels in pre-drilled holes with 1/2" truss head screws provided.

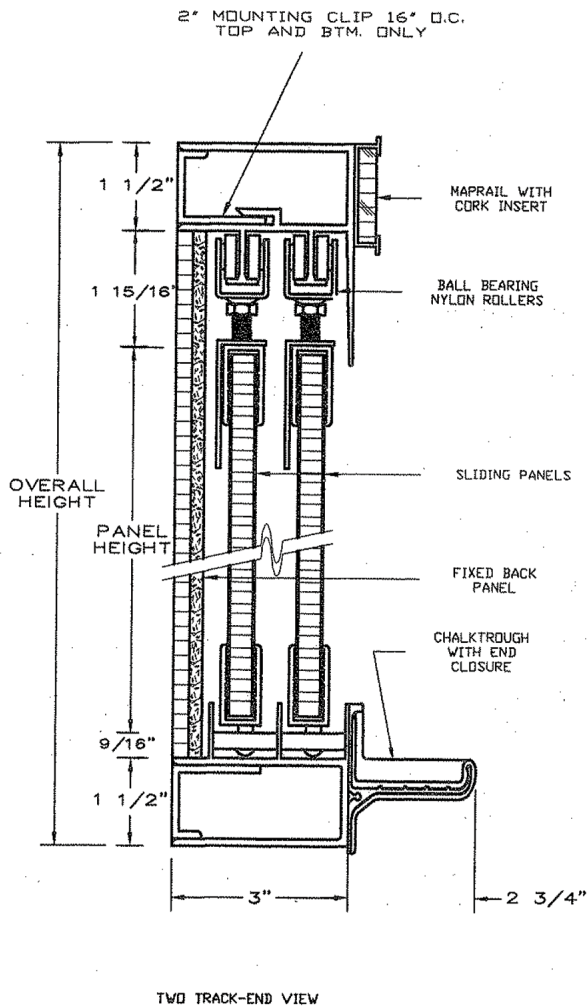

Claridge

800-434-4610  
claridgeproducts.com



### Standard Color Selections

Select from the 3 standard porcelain or 3 chalkboard colors

#### LCS Porcelain Colors - use with markers



No. 100 White

No. 101 Light Gray

No. 102 Beige

#### Chalkboard Colors - use with chalk



No. 500 Green

No. 501 Black

No. 502 Gray

Claridge LCS Porcelain enamel steel markerboard and chalkboard writing surfaces offer unsurpassed durability and performance – a lifetime of performance.

An environmentally friendly process that offers a wide range of decorative and functional colors for use on porcelain markerboards and walls.

- Smooth writing and clean erasing
- Unmatched scratch and stain resistance
- 100% non-combustible surface
- Magnetic surface
- Projection-friendly low gloss LCS surface
- Life of the Building Guarantee
- LCS Porcelain surface is SCS Indoor Advantage Certified

*Colors are reproduced with reasonable accuracy, and are for color identification purposes only.  
If color is critical, contact us at 800-434-4610 to request an actual color sample.*



## LCS PORCELAIN Markerboard and Chalkboard Features

### ENVIRONMENTAL FEATURES

- **SCS Indoor Advantage Certified**

SCS Indoor Advantage certifications are product certification programs for low emitting interior building materials, furnishings and finish systems. SCS Indoor Advantage certified products undergo rigorous testing and must meet stringent standards for low chemical emissions based on established health standards for use in environments such as schools and healthcare facilities.

- **Cradle-to-Cradle™ Bronze Certification**

Cradle-to-Cradle Certification focuses on the characteristics of sustainable materials, products, and systems. The process places emphasis on the human and ecological health impacts of a product's ingredients, and on the ability of that product to be recycled or composted.

Third-party environmental certification assures customers and end users that products selected support healthy indoor air quality and do not emit harmful chemicals. LCS is non-combustible, gives off no toxic gases and is 99.9% recyclable.

### CLEANING INSTRUCTIONS

Claridge LCS Porcelain® enamel steel surfaces are guaranteed to withstand the rigors of everyday use. Proper use and maintenance will ensure performance and keep LCS Porcelain markerboards and chalkboards looking like new. Visit [claridgeproducts.com](http://claridgeproducts.com) for complete cleaning and maintenance instructions.

### WRITING SURFACE WARRANTY

Claridge LCS Porcelain enamel steel markerboard and chalkboard writing surfaces offer unsurpassed durability and performance – a lifetime of performance. We are so confident in the quality and dependability of our LCS Porcelain surfaces that we Guarantee it for the Life of the Building!

### SPECIFICATION

Claridge markerboard and chalkboard surfaces are manufactured in accordance with PEI-1002 Manual and Performance Specifications for LCS Porcelain Enamel Writing Surfaces. The writing surface is made from steel covered on both sides with enamel coatings. Fusion bonded to the steel, the resulting LCS Porcelain surface is smooth, durable and abrasion-resistant providing the best dry-erase surface available.



CLARIDGE CORK  
Color Guide



NO. 1108 MUSHROOM



NO. 1103 OYSTER



NO. 1117 SALSA



NO. 1109 BUFF



NO. 1111 SMOKE

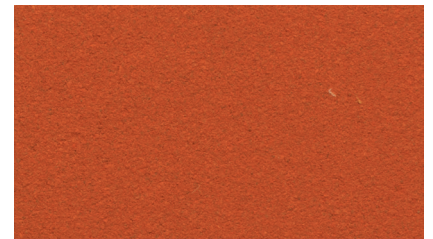

NO. 1118 TANGERINE



NO. 1110 FAWN



NO. 1113 STEEL GRAY



NO. 1119 PINEAPPLE



NO. 1100 TAN



NO. 1136 GRAPHITE



NO. 1120 LETTUCE



NO. 1104 CINNAMON



NO. 1132 BLACK



NO. 1129 BLUEBERRY

Note: Color may vary slightly from samples.



## PRODUCT DESCRIPTION

Claridge Cork is made from pure, natural ingredients including linseed oil, pine resin, cork and pigments that are calendared onto a jute backing to create a smooth, suede-like surface of unsurpassed beauty and exceptional durability.

## FEATURES

- Environmentally friendly
- Tacks insert easily, are gripped firmly
- Does not crack, peel or crumble
- Washable stain-resistant finish
- Expanded color range - 15 harmonizing colors
- Dimensionally stable
- Meets ASTM E-84, NFPA 258 (fuel contribution) - Class B, and NFPA 255 (critical radiant flux) - Class II
- No toxins - no harmful by-products or emissions
- Low light reflectance
- Naturally inhibits bacterial growth

*Note: Features referenced above reflect characteristics of the cork surface only.*





1683 Silver



1690 Grey Mix



1685 Flannel

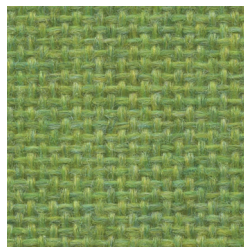

1680 Lime

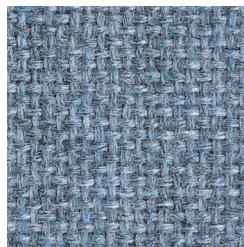

1689 Wedgewood

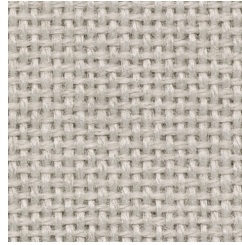

1686 Dark Pearl



1692 Wheat



1693 Sunshine



1688 Cobalt



1691 Quartz



1681 Cement Mix



1679 Cardinal



1684 Noir

*Please note minimal color shade variations may occur from one dye lot to another.*

# TACKBOARD FABRICS

FR701® 2100

## Specifications

Content 100% post-consumer recycled polyester

Weight 16.0 ± 0.5 oz./lin. yd.

Width 66" min. usable

## Acoustical Performance

The plot below summarizes impedance tube measurements of absorption of an anechoic termination and various fabrics in front of the anechoic termination.

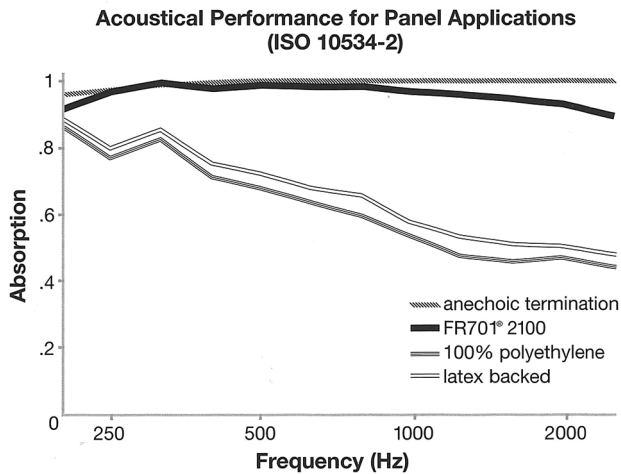

NRC of anechoic termination - 1.00

NRC of fabric in front of anechoic termination - .95

## Performance



Colorfastness to Light (AATCC 16.3 Option 3)  
Grade 4 min. at 40 hours



Colorfastness to Crocking (AATCC 8)  
Grade 4 min. dry & Grade 3 min. wet



Breaking Strength (ASTM D5034)  
150 lbf min. warp and fill



Flammability (ASTM E84)  
Class 1 or A

## Cleaning Code

Clean with water based cleaning agents, foam or pure, water free solvents. Vacuuming or light brushing is recommended to prevent dust and soil buildup.

## Miscellaneous

Colors may vary between dye lots. This is non-directional fabric. Proudly woven in the USA supporting our local communities.



TerraTex is a registered trademark of Truex Textiles, Inc. and designates fabrics that are made from 100% recycled or compostable material using increasingly sustainable manufacturing practices to produce a high quality product that is recyclable at the end of its useful life.



CO<sub>2</sub> emissions from 100% of the electricity used by the manufacturer to produce this product have been measured and offset in accordance with The CarbonNeutral Protocol.



This pattern is included in the underwriters laboratory panel fabric recognition program. Additional testing of this U.L. recognized component fabric is not required on approved panels from participating manufacturers.



800.434.4610  
claridgeproducts.com





**FABRICORK**  
Color Options



KE584 POWER

Claridge Fabricork Vinyl Bulletin Board is made of vinyl coated fabric that will wear almost indefinitely and stay new-looking for years. Fabricork is entirely washable. Spots and soil wash away with household soap and water.

Featuring Koroseal® Wallcovering  
Manufactured by Koroseal Interior Products LLC

*Please note minimal color variation may occur with each dye lot.*



### Viewpoint Pattern

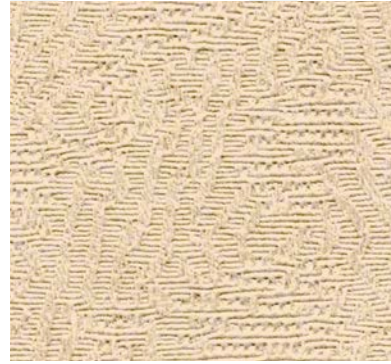

KV216 ECRU

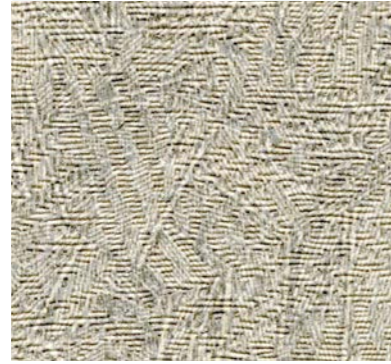

KV230 OYSTER



KV241 WHEAT STRAW



KV237 CURRY



KV233 DRIFTWOOD

### Esquire Pattern



KE522 INNOCENT



KE592 GENTLEMAN GREY



KE510 RUNWAY



KE584 POWER



KE591 COUNSELOR

### Linden Pattern



KL490 RECTORY



KL498 WINTHROPE



KL404 DORSET

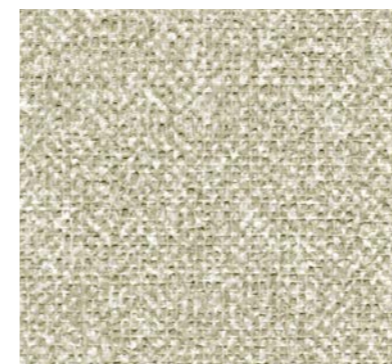

KL483 DOWNING STONE



KL412 ANCESTRAL

### Belair Pattern



KB290 STERLING



KB278 PACIFIC



KB661 DAWN



KB662 GREY



KB664 ANTIQUE





**FEATURES**

- Meets or exceeds Type 1 requirements in Federal Specification CCC-W-408A
- Manufactured with water based inks and coatings
- Has a water based acrylic top coat for improved cleanability
- Cadmium and Mercury Free
- Meets CA 01350 requirements
- Contains Early Warning Effect<sup>®</sup> Life Safety and Property Protection
- Can be supplied Micro-vented to reduce potential for mold and mildew growth

**PATTERNS**

- Viewpoint
- Esquire
- Linden
- Belair

**PROPERTIES**

Total Weight	Viewpoint, Esquire and Linden - 21 oz/linear yd. Belair - 15 oz/linear yd.
Average Thickness	0.017 to 0.021 in.
Tensile (typical)	Viewpoint, Esquire and Linden - 50 x 55 lbf minimum Belair - 30 x 30 lbf minimum
Tear (typical)	Viewpoint, Esquire and Linden - 25 x 25 minimum Belair - 12 x 12 minimum
ASTM E84 Test Results	<b>Class A</b>
Flame Spread	25 or less
Smoke Developed	50 or less

---

Koroseal Interior Products LLC  
Koroseal<sup>®</sup> Wallcovering • [www.koroseal.com](http://www.koroseal.com)

Koroseal<sup>®</sup> and Early Warning Effectare<sup>®</sup>  
trademarks and registered trademarks of  
Koroseal Interior Products LLC.





## TAN NUCORK BULLETIN BOARD SAMPLE



TAN NUCORK is a premium grade, fine grain natural tan composition cork. Nucork is dimensionally stable and has uniform density and particle size.

- An economical tackboard surface, Tan Nucork is pure grain natural cork without burlap backing
- Nucork has a smooth, resilient surface ideal for use with pins or thumbtacks
- 150 FR Nucork has a Class B fire rating based on ASTM E84 tunnel test as follows: flame spread – 65; smoke developed – 70. Meets military specification MIL-C-15116, Type II



800.434.4610  
claridgeproducts.com



# POWDER COATINGS

## Color Guide



An environmentally friendly process that offers a wide range of decorative, functional colors for use on glass markerboards, walls, and metal frames.

### **BENEFITS OF POWDER COATING**

- More durable than baked enamels
- Delivers a brighter, smoother and cleaner finish
- Environmentally friendly, produces less hazardous waste than conventional liquid coatings
- Color choices are virtually unlimited with custom color matching

*Colors are reproduced with reasonable accuracy in standard Gloss finish unless noted Matte.  
If match is critical, contact us at 800-434-4610 for actual samples*



# Powder Coat Colors

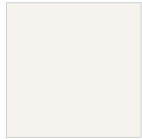

RAL9016  
Traffic White

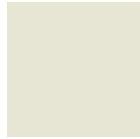

RAL9002  
Grey White



RAL9018  
Papyrus White



RAL7038  
Agate Grey



RAL7035  
Light Grey



RAL7044  
Silk Grey

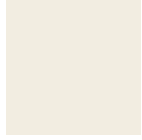

RAL9010  
Pure White

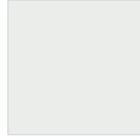

RAL9003  
Signal White

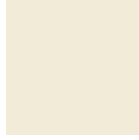

RAL9001  
Cream



RAL7047  
Telegrey 4



RAL7036  
Platinum Grey



RAL7045  
Telegrey 1



RAL7032  
Pebble Grey



RAL7033  
Cement Grey



RAL7042  
Traffic Grey A



RAL7004  
Signal Grey



RAL7046  
Telegrey 2



RAL7037  
Dusty Grey



RAL7030  
Stone Grey



RAL7034  
Yellow Grey



RAL7005  
Mouse Grey



RAL7040  
Window Grey



RAL7012  
Basalt Grey



RAL7043  
Traffic Grey B



RAL7003  
Moss Grey



RAL7013  
Brown Grey



RAL7039  
Quartz Grey



RAL7006  
Beige Grey



RAL7000  
Squirrel Grey



RAL7009  
Green Grey



RAL7001  
Silver Grey



RAL7010  
Tarpaulin Grey



RAL7023  
Concrete Grey



RAL7002  
Olive Grey



RAL7022  
Umbra Grey



RAL7011  
Iron Grey



RAL6006  
Grey Olive



RAL7008  
Khaki Grey



RAL7016  
Anthracite Grey



RAL7026  
Granite Grey



RAL7024  
Graphite Grey



RAL7021  
Black Grey



RAL1013  
Oyster White



RAL1015  
Light Ivory



RAL1014  
Ivory



RAL1000  
Green Beige



RAL1001  
Beige



RAL1011  
Brown Beige



RAL1002  
Sand Yellow



RAL1019  
Grey Beige



RAL1020  
Olive Yellow



RAL1024  
Ochre Yellow



RAL1027  
Curry



RAL1032  
Broom Yellow





RAL1021  
Yellow



RAL1018  
Zinc Yellow



RAL1033  
Dahlia Yellow



RAL2009  
Traffic Orange



RAL2004  
Pure Orange



RAL3004  
Purple Red



RAL1016  
Sulfur Yellow



RAL1012  
Lemon Yellow



RAL1034  
Pastel Yellow



RAL2010  
Signal Orange



RAL2008  
Bright Red Orange



RAL3005  
Wine Red



RAL1028  
Melon Yellow



RAL1023  
Traffic Yellow



RAL2000  
Yellow Orange



RAL2011  
Deep Orange



RAL3002  
Carmine Red



RAL3007  
Black Red



RAL1003  
Signal Yellow



RAL1017  
Saffron Yellow



RAL2001  
Red Orange



RAL2012  
Salmon Orange



RAL3003  
Ruby Red



RAL3009  
Oxide Red



RAL1004  
Golden Yellow



RAL1006  
Maize Yellow



RAL2002  
Vermilion



RAL3000  
Flame Red



RAL3013  
Tomato Red



RAL3011  
Brown Red



RAL1005  
Honey Yellow



RAL1007  
Daffodil Yellow



RAL2003  
Pastel Orange



RAL3001  
Signal Red



RAL3014  
Antique Pink



RAL3012  
Beige Red



RAL3015  
Light Pink

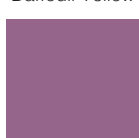

RAL4001  
Red Lilac



RAL4009  
Pastel Violet

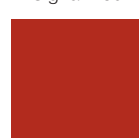

RAL3016  
Coral Red



RAL4002  
Red Violet

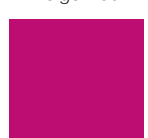

RAL4010  
Telemagenta



RAL4003  
Heather Violet



RAL4005  
Blue Lilac

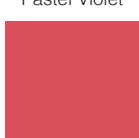

RAL3017  
Rose

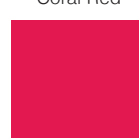

RAL3018  
Strawberry Red



RAL3020  
Traffic Red



RAL4004  
Claret Violet

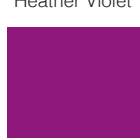

RAL4006  
Traffic Purple



RAL4008  
Signal Violet



RAL3022  
Salmon Pink

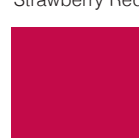

RAL3027  
Raspberry Red

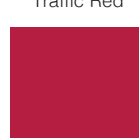

RAL3031  
Orient Red

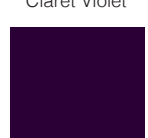

RAL4007  
Purple Violet



RAL5024  
Pastel Blue



RAL5007  
Brilliant Blue



RAL5000  
Violet Blue



RAL5009  
Azure Blue



RAL5018  
Turquoise Blue



RAL6001  
Emerald Green



RAL5015  
Sky Blue



RAL5023  
Distant Blue



RAL5001  
Green Blue



RAL5010  
Gentian Blue



RAL5019  
Capri Blue



RAL6002  
Leaf Green



RAL5017  
Traffic Blue



RAL5014  
Pigeon Blue



RAL5002  
Ultramarine Blue



RAL5011  
Steele Blue



RAL5020  
Ocean Blue



RAL6003  
Olive Green



RAL5005  
Signal Blue



RAL5012  
Light Blue



RAL5003  
Sapphire Blue



RAL5008  
Grey Blue



RAL5021  
Water Blue



RAL6004  
Blue Green



RAL5013  
Cobalt



RAL5022  
Night Blue



RAL5004  
Black Blue



RAL6000  
Patina Green



RAL6034  
Pastel Turquoise



RAL6005  
Moss Green



RAL6007  
Bottle Green



RAL6015  
Black Olive



RAL6024  
Traffic Green



RAL6027  
Light Green



RAL6019  
Pastel Green



RAL6028  
Pine Green



RAL6008  
Brown Green



RAL6016  
Turquoise Green



RAL6025  
Fern Green



RAL6026  
Opal Green



RAL6021  
Pale Green



RAL6029  
Mint Green



RAL6009  
Fir Green

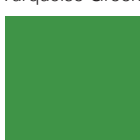

RAL6017  
May Green



RAL6011  
Reseda Green



RAL6013  
Reed Green



RAL6020  
Chrome Green



RAL6032  
Signal Green



RAL6010  
Grass Green

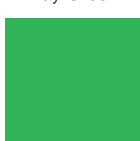

RAL6018  
Yellow Green



RAL6012  
Black Green

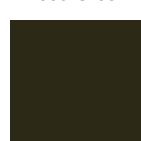

RAL6014  
Yellow Olive

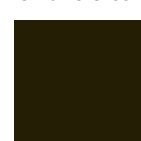

RAL6022  
Olive Drab

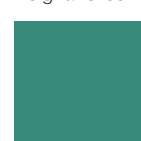

RAL6033  
Mint Turquoise



RAL8015  
Chestnut Brown



RAL8012  
Red Brown



RAL8024  
Beige Brown



RAL8023  
Orange Brown



RAL8002  
Signal Brown



RAL8017  
Chocolate Brown



RAL8019  
Grey Brown



RAL9004  
Signal Black



RAL8008  
Olive Brown



RAL8003  
Clay Brown



RAL8000  
Green Brown



RAL8004  
Copper Brown



RAL8016  
Mahogany Brown

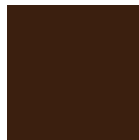

RAL8014  
Sepia Brown



RAL8025  
Pale Brown



RAL8001  
Ocher Brown



RAL8007  
Fawn Brown

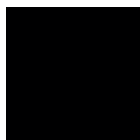

RAL8022  
Black Brown



RAL9005  
Jet Black



RAL9011  
Graphite Black



RAL8011  
Nut Brown



RAL8028  
Terra Brown

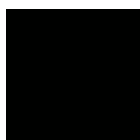





RAL9017  
Traffic Black



*Colors are reproduced with reasonable accuracy in standard Gloss finish unless noted Matte. If match is critical, contact us at 800-434-4610 for actual samples.*

## Standard Color Selections for Aluminum

Claridge offers the durability and brilliance of powder coat finishes for aluminum framed boards, mobile marker-boards cases, display cabinets and virtually any product offered with a metal or extruded aluminum component. Choose from any of the 24 standard colors shown below, or select from more than a 180 optional powder coat color examples inside – including textured and transparent finish choices.

					
RAL1013 Oyster White	RAL2009 Traffic Orange	RAL4001 Red Lilac	RAL5005 Signal Blue	RAL6005 Moss Green	RAL8017 Chocolate Brown
					
RAL1015 Light Ivory	RAL3003 Ruby Red	RAL4004 Claret Violet	RAL5013 Cobalt Blue	RAL6024 Traffic Green	RAL8025 Pale Brown
					
RAL1003 Signal Yellow	RAL3018 Strawberry Red	RAL5000 Violet Blue	RAL5015 Sky Blue	RAL7001 Silver Grey	RAL9003 Signal White
					
RAL1018 Zinc Yellow	RAL3020 Traffic Red	RAL5002 Ultramarine Blue	RAL6002 Leaf Green	RAL7015 Slate Grey	RAL9005 Jet Black

Optional Transparent Finishes					
	Aluminum Only	Transparent Green	Copper	Candy Red	Candy Teal

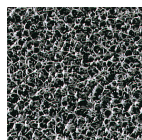
Optional Textured Finishes			
	Aluminum Only	PPLS98550 Antique Copper Vein	PES98116 Goldtone Vein



800.434.4610  
claridgeproducts.com



# Claridge®

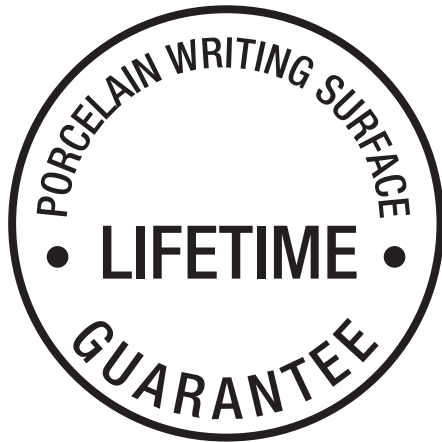

Under normal usage and maintenance, and when installed in accordance with manufacturer's instructions and recommendations, LCS Porcelain enamel steel markerboard and chalkboard writing surfaces are guaranteed for the Life of the Building.

Guarantee covers replacement of defective boards but does not include the cost of removal or re-installation.



Under normal usage and maintenance, Claridge products are guaranteed for one year.

This guarantee covers repair or replacement of the manufactured parts that fail in materials or workmanship within the specified warranty period. Guarantee covers replacement of defective parts only and does not include cost of removal or re-installation.



SCS Global Services does hereby certify that an independent assessment has been conducted on behalf of:

# Claridge Products & Equipment

480 Wrangler Drive, Suite 200, Coppell, TX, United States

For the following product(s):

See Addendum

The product(s) meet(s) all of the necessary qualifications to be certified for the following claim(s):

## Indoor Advantage™ Gold

Indoor Air Quality Certified to SCS-EC10.3-2014 v4.1

Conforms to the ANSI/BIFMA Furniture Emissions Standard (M7.1/X7.1-2011 R2021) and ANSI/BIFMA e.3-2019 (Credits 7.6.1, 7.6.2, 7.6.3) for the open plan and private office workstation parameters.<sup>1</sup> Also, conforms to the CDPH/EHLB Standard Method (CA 01350) v1.2-2017 for the open plan and school classroom parameters.<sup>1</sup>

<sup>1</sup> Modeled as Individual Furniture Components

Registration # SCS-IAQ-09072

Valid from: June 9, 2023 to June 8, 2024



A handwritten signature in black ink that reads "Stanley Mathuram".

Stanley Mathuram, PE, Executive Vice President  
SCS Global Services  
2000 Powell Street, Ste. 600, Emeryville, CA 94608 USA

## **Certification Addendum**

# **Claridge Products & Equipment**

Certification: Registration # SCS-IAQ-09072 | Valid from: June 9, 2023 to June 8, 2024

### **Indoor Advantage™ Gold**

Addendum Indoor Air Quality Certified to SCS-EC10.3-2014 v4.1

Conformance: Conforms to the ANSI/BIFMA Furniture Emissions Standard (M7.1/X7.1-2011 R2021) and ANSI/BIFMA e.3-2019 (Credits 7.6.1, 7.6.2, 7.6.3) for the open plan and private office workstation parameters.<sup>1</sup> Also, conforms to the CDPH/EHLB Standard Method (CA 01350) v1.2-2017 for the open plan and school classroom parameters.<sup>1</sup>

<sup>1</sup> Modeled as Individual Furniture Components

#### **Products: Visual Display Boards:**

213 Series Tackboard with Wood Frame, 309 Sliding Door Display Case, 310 Wood Framed Bulletin Board Cabinet, 3300 Series Tackboard, 3400 Series Tackboard, 344 Wave Lectern, 370 Series Recessed Display Case, 390 Large Door Recessed Display Case, 700 Series Wood, 725 Folding Screen, 742 Freestanding Display Case, 748 Universal Display Case, 79 Hang-Tight Rail System, 800 Series Markerboard, 800 Series Tackboard, 800 Series Type BR/BL Combo Markerboard Tackboard, 900A Tackboard, 94 Combination Map Rail & Clip Strip, Aceno Room Divider Panels-Base, Aceno Storage Cart, Aceno Track System, Arise Marker Walls, Arise Markerboard, Aspire Markerboards, Claridge LCS Porcelain, Classic Series Bulletin Board Cabinet, Classic Series Display Case, Concept Markerboard, Concept Tackboard, Connect X2 3 Caster Mobile Markerboard, Connect X2 Combination Markerboard/Tackboard, Connect X2 Full Height Mobile Markerboard Procelain-Glass, Connect X2 Markerboard Porcelain-Glass, Connect X2 Partial Height Markerboard, Connect X2 Space Creator Porcelain-Cork-Fabric, Connect X2 Tackboard, Contemporary Series Bulletin Board Cabinet, Contemporary Series Bulletin Board Cabinet, Contemporary Style Laminate Lecture Unit, Contemporary Style Wood Lecture Unit, Contio Mobile Markerboard, CS Clip Strips, Cursive Board, Cursive One Markerboard-Tackboard, Custom Printed Glass Boards, Deluxe Series Bulletin Board Cabinet, Deluxe Series Revolving Two-sided Mobile Markerboard, Deluxe Two-sided Mobile Markerboard, Display Case-Cabinet, Economy and Deluxe Map & Display Rail,

## **Certification Addendum**

# **Claridge Products & Equipment**

Certification: Registration # SCS-IAQ-09072 | Valid from: June 9, 2023 to June 8, 2024

### **Indoor Advantage™ Gold**

Addendum Indoor Air Quality Certified to SCS-EC10.3-2014 v4.1

Conformance: Conforms to the ANSI/BIFMA Furniture Emissions Standard (M7.1/X7.1-2011 R2021) and ANSI/BIFMA e.3-2019 (Credits 7.6.1, 7.6.2, 7.6.3) for the open plan and private office workstation parameters.<sup>1</sup> Also, conforms to the CDPH/EHLB Standard Method (CA 01350) v1.2-2017 for the open plan and school classroom parameters.<sup>1</sup>

<sup>1</sup> Modeled as Individual Furniture Components

Products: Edify Mobile Markerboard, EDR Exhibit Rail, Envision Graphics Markerboard, Economy and Deluxe Map & Display Rail, Evolve Markerboard, Evolve Sliding System, Evolve Tackboard, EZ Fit Markerboard Panel, Framed Tackboard, Glass Marker Walls, Glass Markerboards, Horizontal Sliding Markerboards, Imperial Series Bulletin Board Cabinet, Large Contemporary Series Bulletin Board Cabinet, Large Format Glass Marker System, Large Format Porcelain Marker System, LCS Deluxe Combo Markerboard-Tackboard w/Wood frame, LCS Deluxe Markerboard-Aluminum Frame, LCS Deluxe Markerboard-Aluminum Frame No Map Rail, LCS Deluxe Markerboard-Wood Frame, LCS Elite Markerboard, LCS Select Markerboard, LCS Wall-Write Marker Wall, LCS-Glass Combo Boards, Magnetic Glass Markerboard, Magnetic Non-Glare Glass Markerboard, Marker Walls, Merit Series Markerboard, Mina Mobile, Mina Space Creator, MIX Biophilic Mobile, MIX Mobile Glass-Porcelain Markerboard, MIX Mobile Markerboard-Tackboard, MIX Wood Framed Markerboard, MIX Wood Framed Tackboard, MLC405 Presentation Easel, Motif Wood Frame Markerboard, Motif Wood Frame Tackboard, Nimbus Multi-Purpose Mobile, Non-Magnetic Non-Glare Glass Markerboard, Premier Wall Mounted Display Case, Premiere Freestanding Display Case, Premiere Series Reversible Mobile Markerboard w/ aluminum or wood trim, Profile Frameless LCS Porcelain Markerboard, Ravina Markerboard Glass-Porcelain, Ravina Tackboard Fabric-Acoustic, Revere Series Bulletin Board, Revere Series Bulletin Board Cabinet, Ripple Space Divider Acoustic-Acrylic, Series 1 Markerboard, Series 1 Tackboard, Series 1100 Wood Framed Markerboard, Series 1100 Wood Framed Markerboard, Series 1100 Wood Framed Tackboard, Series 2 Markerboard, Series 2 Tackboard,



## **Certification Addendum**

# **Claridge Products & Equipment**

Certification: Registration # SCS-IAQ-09072 | Valid from: June 9, 2023 to June 8, 2024

### **Indoor Advantage™ Gold**

Addendum Indoor Air Quality Certified to SCS-EC10.3-2014 v4.1

Conformance: Conforms to the ANSI/BIFMA Furniture Emissions Standard (M7.1/X7.1-2011 R2021) and ANSI/BIFMA e.3-2019 (Credits 7.6.1, 7.6.2, 7.6.3) for the open plan and private office workstation parameters.<sup>1</sup> Also, conforms to the CDPH/EHLB Standard Method (CA 01350) v1.2-2017 for the open plan and school classroom parameters.<sup>1</sup>

<sup>1</sup> Modeled as Individual Furniture Components

Products: Series 200 Markerboard, Series 200 Tackboard, Series 2000 Markerboard, Series 2000 Tackboard, Series 2100 Wood Framed Markerboard, Series 2100 Wood Framed Tackboard, Series 2500 Markerboard, Series 2900 Markerboard, Series 3 Markerboard, Series 3 Tackboard, Series 4 Markerboard, Series 4 Tackboard, Series 400 Markerboard, Series 400 Tackboard, Series 4000 Markerboard, Series 4000 Tackboard, Series 500 Markerboard, Series 500 Tackboard, Series 6000 Markerboard, Series 6000 Tackboard, Series 8 Markerboard, Series 8 Tackboard, Series 8000 Markerboard, Series 8000 Tackboard, Sliding Marker Wall Systems Porcelain-Glass, Switch Markerboard Porcelain-Glass, Switch Mobile Markerboard Porcelain-Glass, Tableau Markerboard Porcelain-Glass, Tableau Tackboard, Tack Wall, TacPads Acoustic Fabric-Wrapped, Trak-it-system, TrimLine Markerboard, Universal Series Bulletin Board Cabinet, Utility A-Frame Mobile Markerboard, Venue Markerboard Porcelain-Glass, Venue Space Divider Porcelain-Glass Acoustic, Venue T-Leg Mobile Markerboard porcelain-Glass, Venue V-Leg Mobile Markerboard Porcelain-Glass, Vertical Sliding Markerboards, WDR Wooden Display Rail, Wood Frame Bulletin Board Cabinet, Xchange Graphic Board

*Excludes products manufactured with a cork substrate*

*Tackboard included are constructed with a fabricork or designer fabric over Duracore or Micore.*