

PREMIERE

Display Case Cabinet - Freestanding



Features:

- Constructed in one continuous piece, wall support is not required
- Frame is heavy-gauge satin anodized aluminum; inside depth is 13-3/4"
- 3/16" tempered glass sliding doors with locks and keys, and three 6", 8", 10" or 12" wide adjustable glass shelves
- Optional oak or walnut low-pressure laminate base available
- Aluminum legs are 18" high"
- Tackable back panels in Claridge Cork, Fabricork, Guilford of Maine FR701 fabric, Hook-Fab , and Tan Nucork
- Back panels also available in Walnut or Oak grain high-pressure laminate
- Floor leveling glides included

Options:

- Intermediate sizes available
- Lights available
- Medium or dark bronze anodize or powder coat finish

Sizes (HxW)

- 5.5' x 4' x 1'4"
- 5.5' x 5' x 1'4"
- 5.5' x 6' x 1'4"
- 5.5' x 8' x 1'4"
- 5.5' x 10' x 1'4"
- 5.5' x 12' x 1'4"
- 5.5' x 16' x 1'4"



800-434-4610
claridgeproducts.com

[LEARN MORE](#)



Premiere Freestanding Display Case



INSTALLATION INSTRUCTIONS

WARNING

Risk of injury to installers and users

Read the entire assembly directions before beginning assembly.

Tools

Level/Laser

Rubber Mallet

Utility Knife

Installation Instructions

1. The unit has adjustable glides on the bottom of the legs. After the unit is positioned in place. Screw the glides up or down to level the unit. Make sure all the glides have contact with the floor.
2. Insert the shelf bracket into the standard. Use a rubber mallet to tap the bracket down insuring the bracket locks into place. Note: Make sure the brackets for each individual shelf are level.
3. Place shelves on the shelf brackets.
4. Place the sliding door track into the door channel. Refer to the sliding door installation instructions on assembling the door hardware. The back door will need to be placed in the unit first.

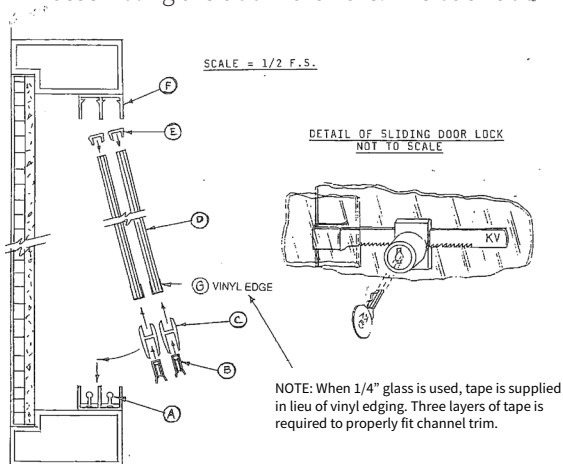

Sliding Door Installation Instructions

1. Insert door rollers "B" into long portion of "H" shaped aluminum door channel "C" approximately 1 1/2" from each end.
2. Install vinyl glazing "G" on bottom edge of glass doors. Vinyl glazing shipped loose.
3. Slide aluminum door channels "C" onto glass doors "D" at vinyl glazing.
4. Slide rubber door guides "E" onto top of glass doors approximately 1 1/2" from each end.
5. Slip entire door assembly upwards into top track "F" and let rollers "B" rest on round portion of lower track assembly "A".



800-434-4610
claridgeproducts.com



CLARIDGE CORK
Color Guide



NO. 1108 MUSHROOM



NO. 1103 OYSTER



NO. 1117 SALSA



NO. 1109 BUFF



NO. 1111 SMOKE

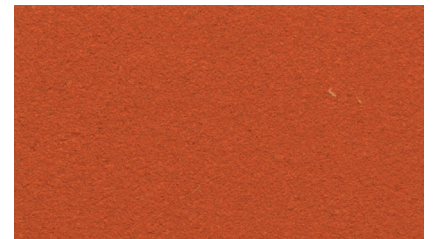

NO. 1118 TANGERINE



NO. 1110 FAWN



NO. 1113 STEEL GRAY



NO. 1119 PINEAPPLE



NO. 1100 TAN



NO. 1136 GRAPHITE



NO. 1120 LETTUCE



NO. 1104 CINNAMON



NO. 1132 BLACK



NO. 1129 BLUEBERRY

Note: Color may vary slightly from samples.



PRODUCT DESCRIPTION

Claridge Cork is made from pure, natural ingredients including linseed oil, pine resin, cork and pigments that are calendared onto a jute backing to create a smooth, suede-like surface of unsurpassed beauty and exceptional durability.

FEATURES

- Environmentally friendly
- Tacks insert easily, are gripped firmly
- Does not crack, peel or crumble
- Washable stain-resistant finish
- Expanded color range - 15 harmonizing colors
- Dimensionally stable
- Meets ASTM E-84, NFPA 258 (fuel contribution) - Class B, and NFPA 255 (critical radiant flux) - Class II
- No toxins - no harmful by-products or emissions
- Low light reflectance
- Naturally inhibits bacterial growth

Note: Features referenced above reflect characteristics of the cork surface only.



1683 Silver



1690 Grey Mix



1685 Flannel

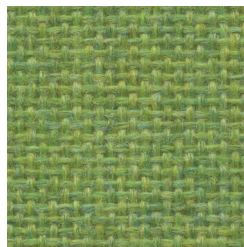

1680 Lime

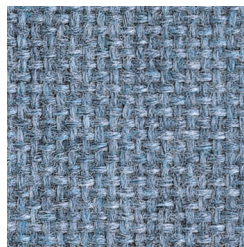

1689 Wedgewood

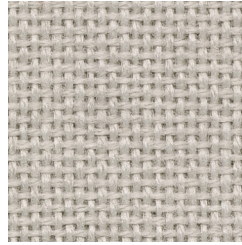

1686 Dark Pearl



1692 Wheat



1693 Sunshine



1688 Cobalt



1691 Quartz



1681 Cement Mix



1679 Cardinal



1684 Noir

Please note minimal color shade variations may occur from one dye lot to another.

TACKBOARD FABRICS

FR701® 2100

Specifications

Content	100% post-consumer recycled polyester
Weight	16.0 ± 0.5 oz./lin. yd.
Width	66" min. usable

Acoustical Performance



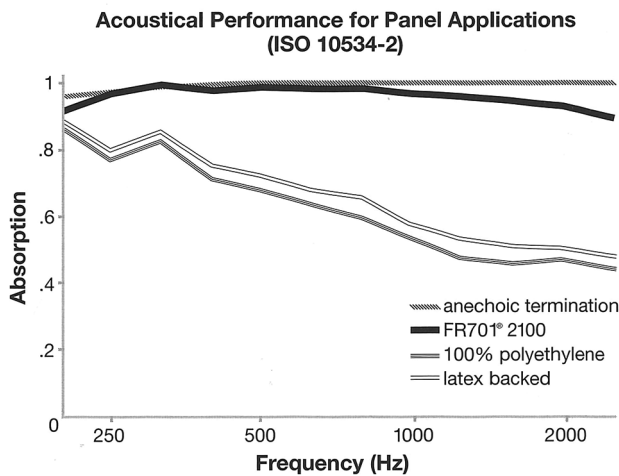

The plot below summarizes impedance tube measurements of absorption of an anechoic termination and various fabrics in front of the anechoic termination.



NRC of anechoic termination - 1.00

NRC of fabric in front of anechoic termination - .95

Performance

-  Colorfastness to Light (AATCC 16.3 Option 3)
Grade 4 min. at 40 hours
-  Colorfastness to Crocking (AATCC 8)
Grade 4 min. dry & Grade 3 min. wet
-  Breaking Strength (ASTM D5034)
150 lbf min. warp and fill
-  Flammability (ASTM E84)
Class 1 or A

Cleaning Code

Clean with water based cleaning agents, foam or pure, water free solvents. Vacuuming or light brushing is recommended to prevent dust and soil buildup.

Miscellaneous

Colors may vary between dye lots. This is non-directional fabric. Proudly woven in the USA supporting our local communities.



TerraTex is a registered trademark of Truex Textiles, Inc. and designates fabrics that are made from 100% recycled or compostable material using increasingly sustainable manufacturing practices to produce a high quality product that is recyclable at the end of its useful life.



CO₂ emissions from 100% of the electricity used by the manufacturer to produce this product have been measured and offset in accordance with The CarbonNeutral Protocol.



This pattern is included in the underwriters laboratory panel fabric recognition program. Additional testing of this U.L. recognized component fabric is not required on approved panels from participating manufacturers.



800.434.4610
claridgeproducts.com



FABRICORK
Color Options

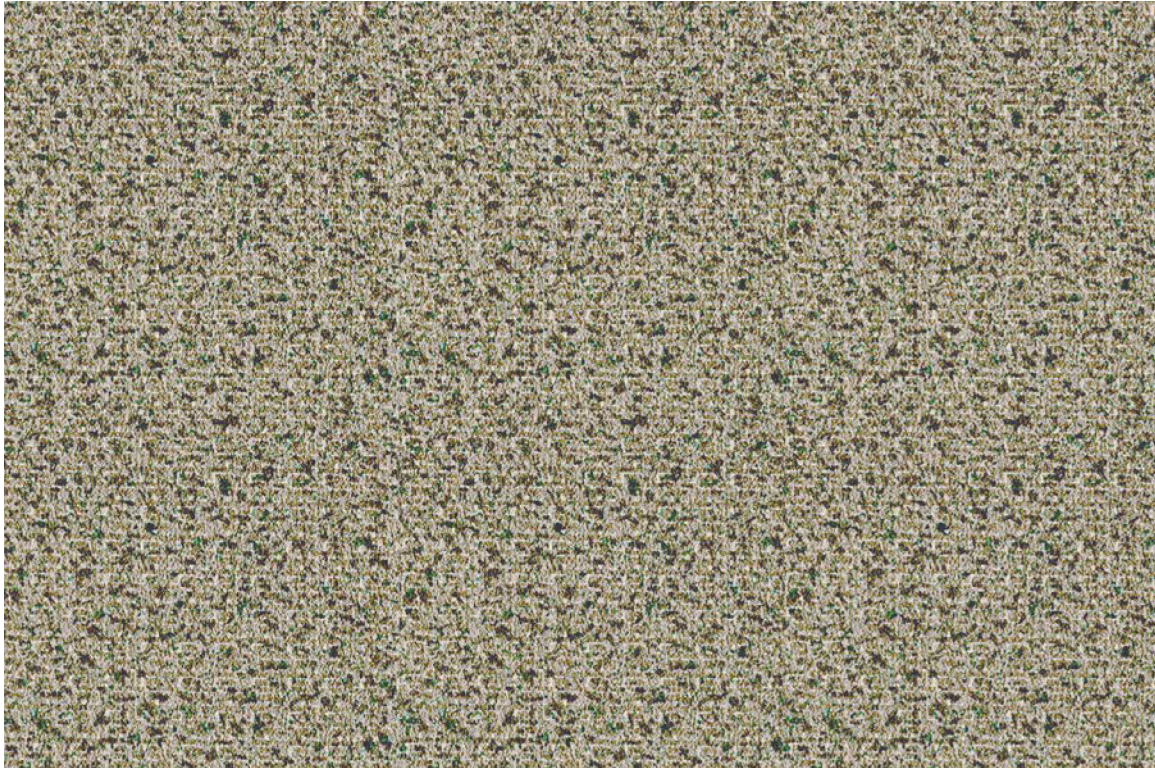

KE584 POWER

Claridge Fabricork Vinyl Bulletin Board is made of vinyl coated fabric that will wear almost indefinitely and stay new-looking for years. Fabricork is entirely washable. Spots and soil wash away with household soap and water.

Featuring Koroseal® Wallcovering
Manufactured by Koroseal Interior Products LLC

Please note minimal color variation may occur with each dye lot.

Viewpoint Pattern

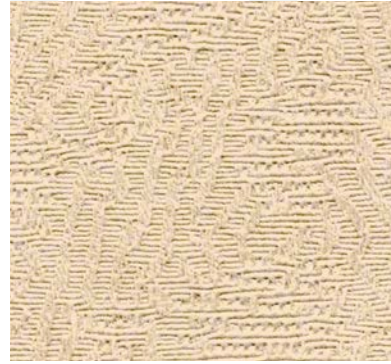

KV216 ECRU

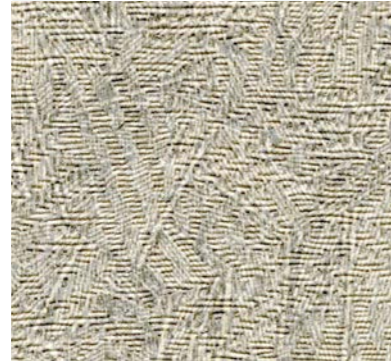

KV230 OYSTER

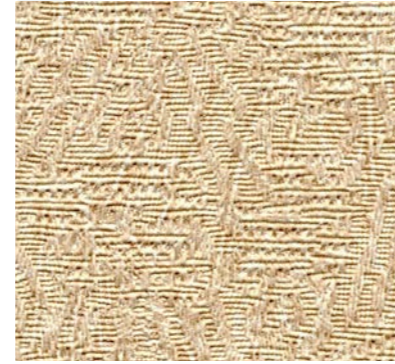

KV241 WHEAT STRAW

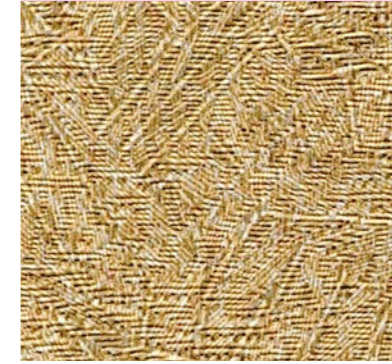

KV237 CURRY



KV233 DRIFTWOOD

Esquire Pattern

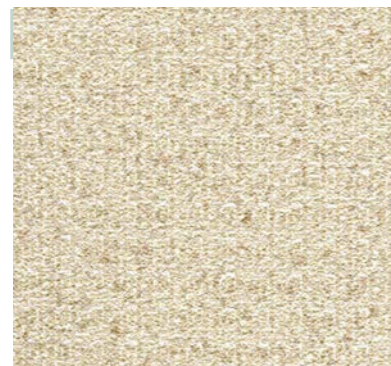

KE522 INNOCENT



KE592 GENTLEMAN GREY



KE510 RUNWAY



KE584 POWER



KE591 COUNSELOR

Linden Pattern



KL490 RECTORY



KL498 WINTHROPE



KL404 DORSET



KL483 DOWNING STONE



KL412 ANCESTRAL

Belair Pattern



KB290 STERLING



KB278 PACIFIC



KB661 DAWN



KB662 GREY



KB664 ANTIQUE

FEATURES

- Meets or exceeds Type 1 requirements in Federal Specification CCC-W-408A
- Manufactured with water based inks and coatings
- Has a water based acrylic top coat for improved cleanability
- Cadmium and Mercury Free
- Meets CA 01350 requirements
- Contains Early Warning Effect[®] Life Safety and Property Protection
- Can be supplied Micro-vented to reduce potential for mold and mildew growth

PATTERNS

- Viewpoint
- Esquire
- Linden
- Belair

PROPERTIES

Total Weight	Viewpoint, Esquire and Linden - 21 oz/linear yd. Belair - 15 oz/linear yd.
Average Thickness	0.017 to 0.021 in.
Tensile (typical)	Viewpoint, Esquire and Linden - 50 x 55 lbf minimum Belair - 30 x 30 lbf minimum
Tear (typical)	Viewpoint, Esquire and Linden - 25 x 25 minimum Belair - 12 x 12 minimum
ASTM E84 Test Results	Class A
Flame Spread	25 or less
Smoke Developed	50 or less

Koroseal Interior Products LLC
Koroseal[®] Wallcovering • www.koroseal.com

Koroseal[®] and Early Warning Effectare[®]
trademarks and registered trademarks of
Koroseal Interior Products LLC.



TAN NUCORK BULLETIN BOARD SAMPLE



TAN NUCORK is a premium grade, fine grain natural tan composition cork. Nucork is dimensionally stable and has uniform density and particle size.

- An economical tackboard surface, Tan Nucork is pure grain natural cork without burlap backing
- Nucork has a smooth, resilient surface ideal for use with pins or thumbtacks
- 150 FR Nucork has a Class B fire rating based on ASTM E84 tunnel test as follows: flame spread – 65; smoke developed – 70. Meets military specification MIL-C-15116, Type II



800.434.4610
claridgeproducts.com



POWDER COATINGS

Color Guide



An environmentally friendly process that offers a wide range of decorative, functional colors for use on glass markerboards, walls, and metal frames.

BENEFITS OF POWDER COATING

- More durable than baked enamels
- Delivers a brighter, smoother and cleaner finish
- Environmentally friendly, produces less hazardous waste than conventional liquid coatings
- Color choices are virtually unlimited with custom color matching

*Colors are reproduced with reasonable accuracy in standard Gloss finish unless noted Matte.
If match is critical, contact us at 800-434-4610 for actual samples*



Powder Coat Colors

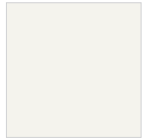

RAL9016
Traffic White

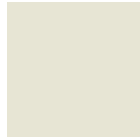

RAL9002
Grey White



RAL9018
Papyrus White



RAL7038
Agate Grey



RAL7035
Light Grey



RAL7044
Silk Grey

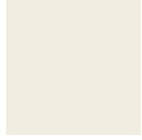

RAL9010
Pure White

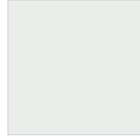

RAL9003
Signal White

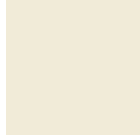

RAL9001
Cream



RAL7047
Telegrey 4



RAL7036
Platinum Grey



RAL7045
Telegrey 1



RAL7032
Pebble Grey



RAL7033
Cement Grey



RAL7042
Traffic Grey A



RAL7004
Signal Grey



RAL7046
Telegrey 2



RAL7037
Dusty Grey



RAL7030
Stone Grey



RAL7034
Yellow Grey



RAL7005
Mouse Grey



RAL7040
Window Grey



RAL7012
Basalt Grey



RAL7043
Traffic Grey B



RAL7003
Moss Grey



RAL7013
Brown Grey



RAL7039
Quartz Grey



RAL7006
Beige Grey



RAL7000
Squirrel Grey



RAL7009
Green Grey



RAL7001
Silver Grey



RAL7010
Tarpaulin Grey



RAL7023
Concrete Grey



RAL7002
Olive Grey



RAL7022
Umbra Grey



RAL7011
Iron Grey



RAL6006
Grey Olive



RAL7008
Khaki Grey



RAL7016
Anthracite Grey



RAL7026
Granite Grey



RAL7024
Graphite Grey



RAL7021
Black Grey



RAL1013
Oyster White



RAL1015
Light Ivory



RAL1014
Ivory



RAL1000
Green Beige



RAL1001
Beige



RAL1011
Brown Beige



RAL1002
Sand Yellow



RAL1019
Grey Beige



RAL1020
Olive Yellow



RAL1024
Ochre Yellow



RAL1027
Curry



RAL1032
Broom Yellow



RAL1021
Yellow



RAL1018
Zinc Yellow



RAL1033
Dahlia Yellow



RAL2009
Traffic Orange



RAL2004
Pure Orange



RAL3004
Purple Red



RAL1016
Sulfur Yellow



RAL1012
Lemon Yellow



RAL1034
Pastel Yellow



RAL2010
Signal Orange



RAL2008
Bright Red Orange



RAL3005
Wine Red



RAL1028
Melon Yellow



RAL1023
Traffic Yellow



RAL2000
Yellow Orange



RAL2011
Deep Orange



RAL3002
Carmine Red



RAL3007
Black Red



RAL1003
Signal Yellow



RAL1017
Saffron Yellow



RAL2001
Red Orange



RAL2012
Salmon Orange



RAL3003
Ruby Red



RAL3009
Oxide Red



RAL1004
Golden Yellow



RAL1006
Maize Yellow



RAL2002
Vermilion



RAL3000
Flame Red



RAL3013
Tomato Red



RAL3011
Brown Red



RAL1005
Honey Yellow



RAL1007
Daffodil Yellow



RAL2003
Pastel Orange



RAL3001
Signal Red



RAL3014
Antique Pink



RAL3012
Beige Red



RAL3015
Light Pink

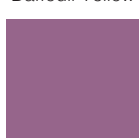

RAL4001
Red Lilac



RAL4009
Pastel Violet

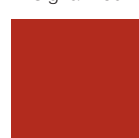

RAL3016
Coral Red



RAL4002
Red Violet

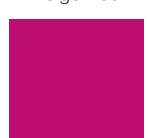

RAL4010
Telemagenta



RAL4003
Heather Violet



RAL4005
Blue Lilac

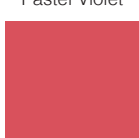

RAL3017
Rose

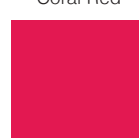

RAL3018
Strawberry Red



RAL3020
Traffic Red



RAL4004
Claret Violet

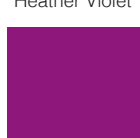

RAL4006
Traffic Purple



RAL4008
Signal Violet



RAL3022
Salmon Pink

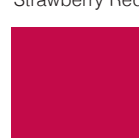

RAL3027
Raspberry Red

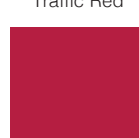

RAL3031
Orient Red

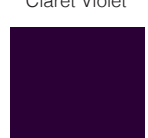

RAL4007
Purple Violet



RAL5024
Pastel Blue



RAL5007
Brilliant Blue



RAL5000
Violet Blue



RAL5009
Azure Blue



RAL5018
Turquoise Blue



RAL6001
Emerald Green



RAL5015
Sky Blue



RAL5023
Distant Blue



RAL5001
Green Blue



RAL5010
Gentian Blue



RAL5019
Capri Blue



RAL6002
Leaf Green



RAL5017
Traffic Blue



RAL5014
Pigeon Blue



RAL5002
Ultramarine Blue



RAL5011
Steele Blue



RAL5020
Ocean Blue



RAL6003
Olive Green



RAL5005
Signal Blue



RAL5012
Light Blue



RAL5003
Sapphire Blue



RAL5008
Grey Blue



RAL5021
Water Blue



RAL6004
Blue Green



RAL5013
Cobalt



RAL5022
Night Blue



RAL5004
Black Blue



RAL6000
Patina Green



RAL6034
Pastel Turquoise



RAL6005
Moss Green



RAL6007
Bottle Green



RAL6015
Black Olive



RAL6024
Traffic Green



RAL6027
Light Green



RAL6019
Pastel Green



RAL6028
Pine Green



RAL6008
Brown Green



RAL6016
Turquoise Green



RAL6025
Fern Green



RAL6026
Opal Green



RAL6021
Pale Green



RAL6029
Mint Green



RAL6009
Fir Green

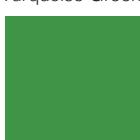

RAL6017
May Green



RAL6011
Reseda Green



RAL6013
Reed Green



RAL6020
Chrome Green



RAL6032
Signal Green



RAL6010
Grass Green

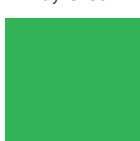

RAL6018
Yellow Green



RAL6012
Black Green



RAL6014
Yellow Olive

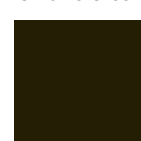

RAL6022
Olive Drab

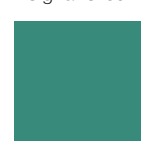

RAL6033
Mint Turquoise



RAL8015
Chestnut Brown



RAL8012
Red Brown



RAL8024
Beige Brown



RAL8023
Orange Brown



RAL8002
Signal Brown



RAL8017
Chocolate Brown



RAL8019
Grey Brown



RAL9004
Signal Black



RAL8008
Olive Brown



RAL8003
Clay Brown



RAL8000
Green Brown



RAL8004
Copper Brown



RAL8016
Mahogany Brown

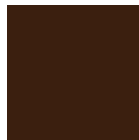

RAL8014
Sepia Brown



RAL8025
Pale Brown



RAL8001
Ocher Brown



RAL8007
Fawn Brown

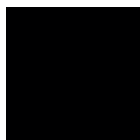

RAL8022
Black Brown



RAL9005
Jet Black



RAL9011
Graphite Black



RAL8011
Nut Brown



RAL8028
Terra Brown

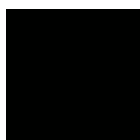

RAL9017
Traffic Black

Colors are reproduced with reasonable accuracy in standard Gloss finish unless noted Matte. If match is critical, contact us at 800-434-4610 for actual samples.

Standard Color Selections for Aluminum

Claridge offers the durability and brilliance of powder coat finishes for aluminum framed boards, mobile marker-boards cases, display cabinets and virtually any product offered with a metal or extruded aluminum component. Choose from any of the 24 standard colors shown below, or select from more than a 180 optional powder coat color examples inside – including textured and transparent finish choices.

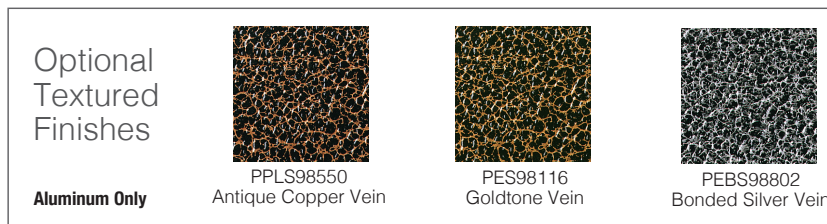
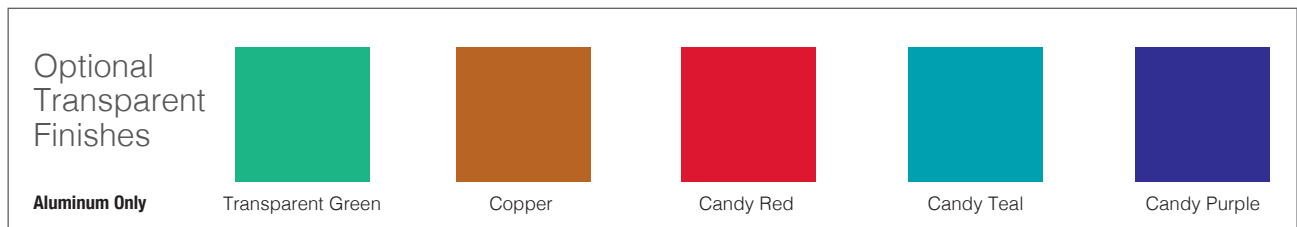

800.434.4610
claridgeproducts.com



Under normal usage and maintenance, Claridge products are guaranteed for one year.

This guarantee covers repair or replacement of the manufactured parts that fail in materials or workmanship within the specified warranty period. Guarantee covers replacement of defective parts only and does not include cost of removal or re-installation.



SCS Global Services does hereby certify that an independent assessment has been conducted on behalf of:

Claridge Products & Equipment

480 Wrangler Drive
Suite 200, Coppell, 75019, United States

For the following product(s):

See Addendum

The product(s) meet(s) all of the necessary qualifications to be certified for the following claim(s):

Indoor Advantage™ Gold

Indoor Air Quality Certified to SCS-105 v4.2

Conforms to the ANSI/BIFMA Furniture Emissions Standard (M7.1/X7.1-2011 R2021) and ANSI/BIFMA e.3-2019 (Credits 7.6.2, 7.6.3) for the open plan and (Credits 7.6.1, 7.6.2, 7.6.3) private office workstation parameters.¹ Also, conforms to the CDPH/EHLB Standard Method (CA 01350) v1.2-2017 for the open plan and school classroom parameters.¹

¹Modeled as Individual Furniture Components

Registration # SCS-IAQ-09072

Valid from: November 04, 2024 to June 08, 2025



INDOOR ADVANTAGE GOLD
FURNITURE



ANSI National Accreditation Board
ACCREDITED

ISO/IEC 17065
PRODUCT CERTIFICATION
BODY



Diana Kirsanova Phillips, Chief Assurance
Officer,
SCS Global Services

Certification Addendum

Claridge Products & Equipment

Certification: Registration # SCS-IAQ-09072 | Valid from: November 04, 2024 to June 08, 2025

Addendum **Indoor Advantage™ Gold**

Conformance: Indoor Air Quality Certified to SCS-105 v4.2

Conforms to the ANSI/BIFMA Furniture Emissions Standard (M7.1/X7.1-2011 R2021) and ANSI/BIFMA e.3-2019 (Credits 7.6.2, 7.6.3) for the open plan and (Credits 7.6.1, 7.6.2, 7.6.3) private office workstation parameters.¹ Also, conforms to the CDPH/EHLB Standard Method (CA 01350) v1.2-2017 for the open plan and school classroom parameters.¹

¹Modeled as Individual Furniture Components

Products:

Visual Display Boards:

3300 Series Tackboard, 3400 Series Tackboard, 344 Wave Lectern, 370 Series Recessed Display Case, 390 Large Door Recessed Display Case, 725 Folding Screen, 748 Universal Display Case, 79 Hang-Tight Rail System, 800 Series Markerboard, 800 Series Tackboard, 800 Series Type BR/BL Combo Markerboard Tackboard, 900A Tackboard, 94 Combination Map Rail & Clip Strip, Aceno Room Divider Panels-Base, Aceno Track System, Arise Marker Walls, Arise Markerboard, Aspire Markerboards, Claridge LCS Porcelain, Classic Series Bulletin Board Cabinet, Classic Series Display Case, Concept Markerboard, Concept Tackboard, Connect X2 3 Caster Mobile Markerboard, Connect X2 Combination Markerboard/Tackboard, Connect X2 Full Height Mobile Markerboard Porcelain-Glass, Connect X2 Markerboard Porcelain-Glass, Connect X2 Partial Height Markerboard, Connect X2 Space Creator Porcelain-Cork-Fabric, Connect X2 Tackboard, Contemporary Series Bulletin Board Cabinet, Contemporary Series Bulletin Board Cabinet, Contemporary Style Laminate Lecture Unit, Contio Mobile Markerboard, CS Clip Strips, Cursive Board, Cursive One Markerboard-Tackboard, Custom Printed Glass Boards, Deluxe Series Bulletin Board Cabinet, Deluxe Series Revolving Two-sided Mobile Markerboard, Deluxe Two-sided Mobile Markerboard, Display Case-Cabinet, Economy and Deluxe Map & Display Rail, Edify Mobile Markerboard, EDR Exhibit Rail, Envision Graphics Markerboard, Economy and Deluxe Map & Display Rail, Evolve Markerboard, Evolve Sliding System, Evolve Tackboard, EZ Fit Markerboard Panel, Framed Tackboard, Glass Marker Walls, Glass Markerboards, Horizontal Sliding Markerboards, Imperial Series Bulletin Board Cabinet, Large Contemporary Series Bulletin Board Cabinet, Large Format Glass Marker System, Large Format Porcelain Marker System, LCS Deluxe Markerboard-Aluminum Frame,

Certification Addendum **Claridge Products & Equipment**

Certification: Registration # SCS-IAQ-09072 | Valid from: November 04, 2024 to June 08, 2025

Addendum **Indoor Advantage™ Gold**

Conformance: Indoor Air Quality Certified to SCS-105 v4.2

Conforms to the ANSI/BIFMA Furniture Emissions Standard (M7.1/X7.1-2011 R2021) and ANSI/BIFMA e.3-2019 (Credits 7.6.2, 7.6.3) for the open plan and (Credits 7.6.1, 7.6.2, 7.6.3) private office workstation parameters.¹ Also, conforms to the CDPH/EHLB Standard Method (CA 01350) v1.2-2017 for the open plan and school classroom parameters.¹

¹Modeled as Individual Furniture Components

Products:

Visual Display Boards Continued:

LCS Deluxe Markerboard-Aluminum Frame No Map Rail, LCS Deluxe Markerboard-Wood Frame, LCS Elite Markerboard, LCS Select Markerboard, LCS Wall-Write Marker Wall, LCS-Glass Combo Boards, Magnetic Glass Markerboard, Magnetic Non-Glare Glass Markerboard, Marker Walls, Merit Series Markerboard, Mina Mobile, Mina Space Creator, Non-Magnetic Non-Glare Glass Markerboard, Premier Wall Mounted Display Case, Premiere Freestanding Display Case, Premiere Series Reversible Mobile Markerboard w/ aluminum trim, Profile Frameless LCS Porcelain Markerboard, Revere Series Bulletin Board, Revere Series Bulletin Board Cabinet, Ripple Space Divider Acoustic-Acrylic, Series 1 Markerboard, Series 1 Tackboard, Series 5 Markerboard, Series 5 Tackboard, Series 2 Markerboard, Series 2 Tackboard, Series 2500 Markerboard, Series 3 Markerboard, Series 3 Tackboard, Series 4 Markerboard, Series 4 Tackboard, Series 8 Markerboard, Series 8 Tackboard, Sliding Marker Wall Systems Porcelain-Glass, Switch Markerboard Porcelain-Glass, Switch Mobile Markerboard Porcelain-Glass, Tableau Markerboard Porcelain-Glass, Tableau Tackboard, Tack Wall, TacPads Acoustic Fabric-Wrapped, Trak-it-system, TrimLine Markerboard, Universal Series Bulletin Board Cabinet, Utility A-Frame Mobile Markerboard, Venue Markerboard Porcelain-Glass, Venue Space Divider Porcelain-Glass Acoustic, Venue T-Leg Mobile Markerboard porcelain-Glass, Venue V-Leg Mobile Markerboard Porcelain-Glass, Vertical Sliding Markerboards, Xchange Graphic Board

Excludes products with wood trim. Excludes products manufactured with a cork substrate. Tackboard included are constructed with a fabricork or designer fabric over Duracore or Micore.